

## RoHS Recast Compliant M.2 2280 Anti-Sulfuration Solid State Drive

### SV250-M280 BiCS3 Product Specifications

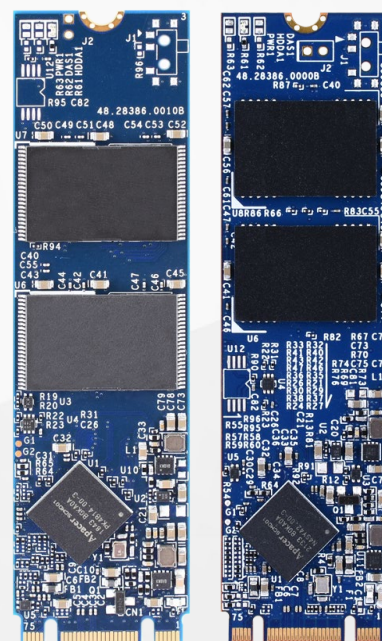

April 20, 2023

Version 1.1



**Apacer Technology Inc.**

1F, No.32, Zhongcheng Rd., Tucheng Dist., New Taipei City, Taiwan, R.O.C

Tel: +886-2-2267-8000 Fax: +886-2-2267-2261

[www.apacer.com](http://www.apacer.com)

## Specifications Overview:

- **Compliance with SATA Revision 3.2**
  - SATA 6 Gb/s interface
  - ATA-8 command set
  - Backward compatible with SATA 1.5/3 Gb/s
- **Capacity**
  - Single-sided: 30, 60, 120, 240, 480 GB
  - Double-sided: 960 GB
- **Performance<sup>1</sup>**
  - Burst read/write: 600 MB/sec
  - Sequential read: Up to 560 MB/sec
  - Sequential write: Up to 520 MB/sec
  - Random read (4K): Up to 51,000 IOPS
  - Random write (4K): Up to 73,000 IOPS
- **Flash Management**
  - Low-Density Parity-Check (LDPC) Code
  - Global Wear Leveling
  - Flash bad-block management
  - Flash Translation Layer: Page Mapping
  - S.M.A.R.T.
  - DataDefender™
  - Device Sleep
  - ATA Secure Erase
  - TRIM
  - Hyper Cache Technology
  - Over-provisioning
  - DataRAID™
  - SMART Read Refresh™
- **Endurance (in drive writes per day: DWPD)**
  - 30 GB: 3.27 DWPD
  - 60 GB: 3.45 DWPD
  - 120 GB: 3.4 DWPD
  - 240 GB: 3.34 DWPD
  - 480 GB: 3.4 DWPD
  - 960 GB: 3.35 DWPD
- **Temperature Range**
  - Operating:
    - Standard: 0°C to 70°C
    - Wide: -40°C to 85°C
  - Storage: -40°C to 100°C
- **Supply Voltage**
  - 3.3V ± 5%
- **Power Consumption<sup>1</sup>**
  - Active mode (Max.): 450 mA
  - Idle mode: 70 mA
- **SATA Power Management Modes**
- **Connector Type**
  - 75-pin SATA-based M.2 module pinout
- **NAND Flash Type:** 3D TLC (BiCS3)
- **MTBF:** >3,000,000 hours
- **Form Factor**
  - Single-sided: M.2 2280-S3-B-M
  - Double-sided: M.2 2280-D5-B-M
  - Dimensions (unit: mm):
    - Single-sided: 80.00 x 22.00 x 2.38<sub>(max.)</sub>
    - Double-sided: 80.00 x 22.00 x 3.88<sub>(max.)</sub>
  - Net weight: 6.48g ± 5%
- **Security**
  - AES 256-bit hardware encryption
- **Reliability**
  - Thermal Sensor
  - End-to-End Data Protection
  - Anti-Sulfuration
- **LED Indicators for Drive Behavior**
- **RoHS Recast Compliant (Complies with 2011/65/EU Standard)**

Note:

1. Varies from capacities. The values for performances and power consumptions presented are typical and may vary depending on flash configurations or platform settings. The term idle refers to the standby state of the device.

## Table of Contents

|   |           |
|---|-----------|
| <b>1. General Description .....</b>               | <b>4</b>  |
| <b>2. Functional Block .....</b>                  | <b>5</b>  |
| <b>3. Pin Assignments.....</b>                    | <b>6</b>  |
| <b>4. Product Specifications.....</b>             | <b>9</b>  |
| 4.1 Capacity.....                                 | 9         |
| 4.2 Performance .....                             | 9         |
| 4.3 Environmental Specifications .....            | 10        |
| 4.4 Mean Time Between Failures (MTBF) .....       | 10        |
| 4.5 Certification and Compliance.....             | 10        |
| 4.6 Endurance .....                               | 11        |
| 4.7 LED Indicator Behavior.....                   | 11        |
| <b>5. Flash Management .....</b>                  | <b>12</b> |
| 5.1 Error Correction/Detection.....               | 12        |
| 5.2 Bad Block Management .....                    | 12        |
| 5.3 Global Wear Leveling .....                    | 12        |
| 5.4 DataDefender™.....                            | 12        |
| 5.5 ATA Secure Erase .....                        | 12        |
| 5.6 TRIM.....                                     | 13        |
| 5.7 Flash Translation Layer – Page Mapping.....   | 13        |
| 5.8 Device Sleep (DevSleep or DEVSLP) Mode.....   | 13        |
| 5.9 Hyper Cache Technology .....                  | 13        |
| 5.10 Over-provisioning .....                      | 14        |
| 5.11 SATA Power Management.....                   | 14        |
| 5.12 DataRAID™ .....                              | 14        |
| 5.13 SMART Read Refresh™ .....                    | 14        |
| <b>6. Security and Reliability Features .....</b> | <b>15</b> |
| 6.1 Anti-Sulfuration .....                        | 15        |
| 6.2 Advanced Encryption Standard .....            | 15        |
| 6.3 End-to-End Data Protection.....               | 15        |
| 6.4 Thermal Sensor .....                          | 15        |
| <b>7. Software Interface .....</b>                | <b>16</b> |
| 7.1 Command Set.....                              | 16        |

|  |           |
|--|-----------|
| 7.2 S.M.A.R.T. ....                          | 17        |
| <b>8. Electrical Specifications.....</b>     | <b>18</b> |
| 8.1 Operating Voltage.....                   | 18        |
| 8.2 Power Consumption .....                  | 18        |
| <b>9. Mechanical Specifications.....</b>     | <b>19</b> |
| 9.1 TSOP Single Side (30-60GB).....          | 19        |
| 9.2 BGA (120-960GB) .....                    | 20        |
| 9.3 Net Weight.....                          | 21        |
| <b>10. Product Ordering Information.....</b> | <b>22</b> |
| 10.1 Product Code Designations.....          | 22        |
| 10.2 Valid Combinations.....                 | 23        |

## 1. General Description

Apacer's SV250-M280, utilizing 3D NAND for higher capacity up to 960GB and providing more power efficiency than 2D NAND, is the next generation Solid State Drive (SSD) with compact and high-speed storage. Designed in SATA 6 Gb/s interface, SV250-M280 provides full compliance with the latest SATA Revision 3.2 interface specifications and delivers exceptional performance up to 560/520 MB/s and 51,000/73,000 in sequential and IOPS read/write, making it the leading add-in storage solution for future host computing systems.

Featuring anti-sulfuration technology, SV250-M280 not only uses special alloy materials but also achieves a complete air barrier through rigorously inspected special materials and technologies in compliance with the ANSI/ISA 71.04-2013 standard to increase system lifetime and ensure product reliability and durability.

Regarding reliability, SV250-M280 is built with a powerful SATA controller that supports on-the-module ECC as well as efficient wear leveling scheme and implemented with LDPC (Low Density Parity Check) ECC engine to extend SSD endurance and increase data reliability. Furthermore, SV250-M280 is equipped with a built-in thermal sensor to monitor the temperature of the SSD via S.M.A.R.T commands to prevent overheating. Operating under 6 Gb/s interface, SV250-M280 is provided with Apacer latest S.M.A.R.T. that is primarily oriented for the latest SATA interface SSD, for drive lifetime monitoring and analysis. For highly-intensive applications, End-to-End Data Protection ensures that data integrity can be assured at multiple points in the path to enable reliable delivery of data transfers.

Security-wise, Advanced Encryption Standard (AES) ensures data security and provides users with peace of mind knowing their data is safeguarded against unauthorized use at all times. SV250-M280 also adopts the latest page mapping file translation layer and comes with various implementations including power saving modes, wear leveling, flash block management, S.M.A.R.T., TRIM, Hyper Cache technology, DataDefender™ and SMART Read Refresh™.

With exceptional performance, trustable reliability and enhanced data protection, SV250-M280 is definitely the ideal storage or cache solution for a variety of applications ranging from industrial, imaging, computing to enterprise markets.

## 2. Functional Block

Apacer SV250-M280 includes a single-chip controller and flash media. The controller integrates the flash management unit to support multi-channel, multi-bank flash arrays. Figure 2-1 shows the functional block diagram.

Note: The actual number of NAND flash used on Apacer SV250-M280 varies from capacities. The illustration is for reference only.

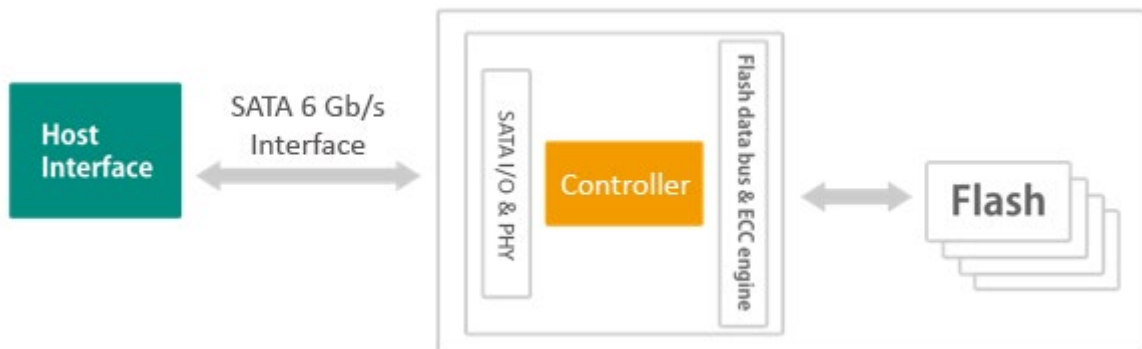

Figure 2-1 Functional Block Diagram

### 3. Pin Assignments

This connector does not support hot plug capability. There are a total of 75 pins. 12 pin locations are used for mechanical key locations; this allows such a module to plug into both Key B and Key M connectors.

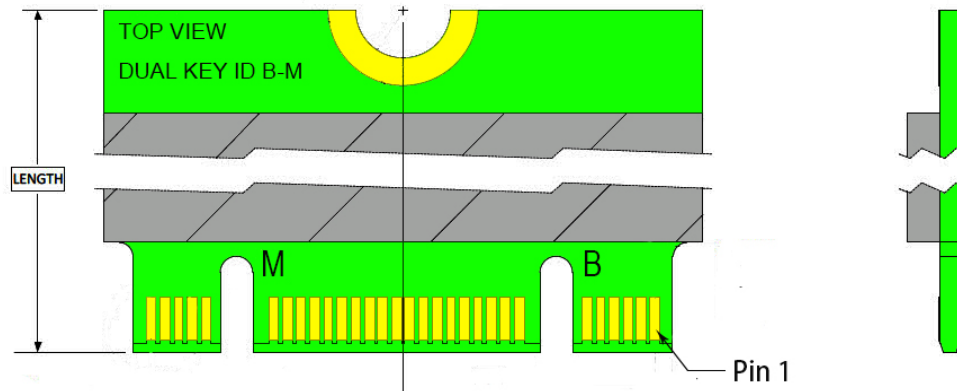

Figure 3-1 SATA Connectors

Table 3-1 Pin Assignments

| Pin No. | Type              | Description  |
|---------|-------------------|--|
| 1       | CONFIG_3          | Ground (according to M.2 configurations for SSD-SATA definition) |
| 2       | 3.3V              | Supply Pin, 3.3V   |
| 3       | GND               | Ground   |
| 4       | 3.3V              | Supply pin, 3.3V   |
| 5       | No connect        | No connect   |
| 6       | Not available     | No connect   |
| 7       | Not available     | No connect   |
| 8       | Not available     | Reserved for Apacer use only <sup>1</sup>                        |
| 9       | No connect        | No connect   |
| 10      | DAS/DSS           | Device Activity Signal/Disable Staggered Spin-up                 |
| 11      | No connect        | No connect   |
| 12      | (removed for key) | Mechanical notch B   |
| 13      | (removed for key) | Mechanical notch B   |
| 14      | (removed for key) | Mechanical notch B   |
| 15      | (removed for key) | Mechanical notch B   |
| 16      | (removed for key) | Mechanical notch B   |
| 17      | (removed for key) | Mechanical notch B   |
| 18      | (removed for key) | Mechanical notch B   |
| 19      | (removed for key) | Mechanical notch B   |
| 20      | Not available     | No connect   |
| 21      | CONFIG_0          | Ground (according to M.2 configurations for SSD-SATA definition) |
| 22      | Not available     | No connect   |
| 23      | Not available     | No connect   |

**Table 3-1 Pin Assignments**

| Pin No. | Type              | Description  |
|---------|-------------------|--|
| 24      | Not available     | No connect   |
| 25      | Not available     | No connect   |
| 26      | Not available     | No connect   |
| 27      | GND               | Ground   |
| 28      | Not available     | No connect   |
| 29      | PERn1             | No connect   |
| 30      | Not available     | No connect   |
| 31      | PERp1             | No connect   |
| 32      | Not available     | No connect   |
| 33      | GND               | Ground   |
| 34      | Not available     | No connect   |
| 35      | PETn1             | No connect   |
| 36      | Not available     | No connect   |
| 37      | PETp1             | No connect   |
| 38      | DEVSLP            | Device Sleep, input. If driven high the host is informing the SSD to enter a low power state |
| 39      | GND               | Ground   |
| 40      | Not available     | No connect   |
| 41      | SATA-Rx+          | Host receiver differential signal pair   |
| 42      | Not available     | No connect   |
| 43      | SATA-Rx-          | Host receiver differential signal pair   |
| 44      | Not available     | No connect   |
| 45      | GND               | Ground   |
| 46      | Not available     | No connect   |
| 47      | SATA-Tx-          | Host transmitter differential pair   |
| 48      | Not available     | No connect   |
| 49      | SATA-Tx+          | Host transmitter differential pair   |
| 50      | PERST#            | No connect   |
| 51      | GND               | Ground   |
| 52      | CLKREQ#           | No connect   |
| 53      | REFCLKN           | No connect   |
| 54      | PEWAKE#           | No connect   |
| 55      | REFCLKP           | No connect   |
| 56      | MFG1              | Reserved for Apacer use only <sup>1</sup>  |
| 57      | GND               | Ground   |
| 58      | MFG2              | Reserved for Apacer use only <sup>1</sup>  |
| 59      | (removed for key) | Mechanical notch M   |
| 60      | (removed for key) | Mechanical notch M   |
| 61      | (removed for key) | Mechanical notch M   |
| 62      | (removed for key) | Mechanical notch M   |
| 63      | (removed for key) | Mechanical notch M   |

**Table 3-1 Pin Assignments**

| Pin No. | Type              | Description        |
|---------|-------------------|--------------------|
| 64      | (removed for key) | Mechanical notch M |
| 65      | (removed for key) | Mechanical notch M |
| 66      | (removed for key) | Mechanical notch M |
| 67      | Not available     | No connect         |
| 68      | SUSCLK            | No connect         |
| 69      | CONFIG_1          | Ground             |
| 70      | 3.3V              | Supply pin, 3.3V   |
| 71      | GND               | Ground             |
| 72      | 3.3V              | Supply pin, 3.3V   |
| 73      | GND               | Ground             |
| 74      | 3.3V              | Supply pin, 3.3V   |
| 75      | CONFIG_2          | Ground             |

Note:

1. Reserved by Apacer, please do not connect to a host.

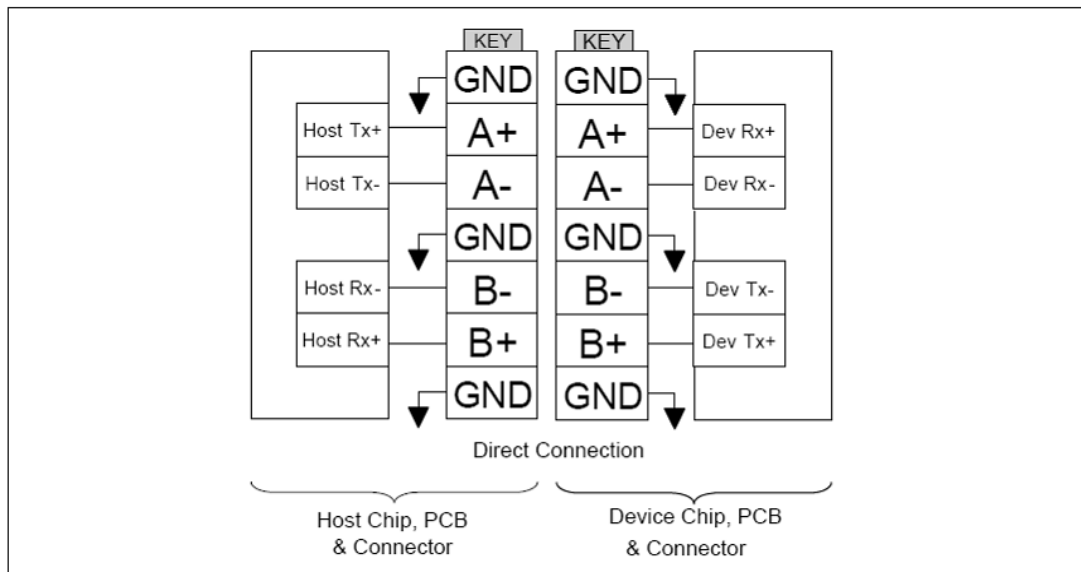

**Figure 3-2 Direct Connection between the Host and Device**

## 4. Product Specifications

### 4.1 Capacity

Capacity specifications of SV250-M280 are available as shown in Table 4-1. It lists the specific capacity and the default numbers of heads, sectors and cylinders for each product line.

**Table 4-1 Capacity Specifications**

| Capacity | Total bytes     | Cylinders | Heads | Sectors | Total LBA     |
|----------|-----------------|-----------|-------|---------|---------------|
| 30 GB    | 30,016,659,456  | 16,383    | 16    | 63      | 58,626,288    |
| 60 GB    | 60,022,480,896  | 16,383    | 16    | 63      | 117,231,408   |
| 120 GB   | 120,034,123,776 | 16,383    | 16    | 63      | 234,441,648   |
| 240 GB   | 240,057,409,536 | 16,383    | 16    | 63      | 468,862,128   |
| 480 GB   | 480,103,981,056 | 16,383    | 16    | 63      | 937,703,088   |
| 960 GB   | 960,197,124,096 | 16,383    | 16    | 63      | 1,875,385,008 |

Notes:

- Display of total bytes varies from operating systems.
- 1 GB = 1,000,000,000 bytes; 1 sector = 512 bytes.
- LBA count addressed in the table above indicates total user storage capacity and will remain the same throughout the lifespan of the device. However, the total usable capacity of the SSD is most likely to be less than the total physical capacity because a small portion of the capacity is reserved for device maintenance usages.

### 4.2 Performance

Performance of SV250-M280 is listed below in Table 4-2.

**Table 4-2 Performance Specifications**

| Performance                    | Capacity |        |        |        |        |        |
|--------------------------------|----------|--------|--------|--------|--------|--------|
|                                | 30 GB    | 60 GB  | 120 GB | 240 GB | 480 GB | 960 GB |
| <b>Sequential Read (MB/s)</b>  | 215      | 425    | 560    | 560    | 560    | 560    |
| <b>Sequential Write (MB/s)</b> | 125      | 260    | 475    | 510    | 515    | 520    |
| <b>4K Random Read (IOPS)</b>   | 8,000    | 19,000 | 34,000 | 51,000 | 51,000 | 51,000 |
| <b>4K Random Write (IOPS)</b>  | 17,000   | 58,000 | 73,000 | 73,000 | 73,000 | 73,000 |

Notes:

- Results may differ from various flash configurations or host system setting.
- Sequential read/write is based on CrystalDiskMark 5.2.1 with file size 1,000MB.
- Random read/write is measured using IOMeter with Queue Depth 32.

### 4.3 Environmental Specifications

Environmental specifications of SV250-M280 product are shown in Table 4-3.

**Table 4-3 Environmental Specifications**

| Parameter   | Type          | Specifications  |
|-------------|---------------|---|
| Temperature | Operating     | 0°C to 70°C (Standard); -40°C to 85°C (Wide)                          |
|             | Non-operating | -40°C to 100°C  |
| Vibration   | Operating     | 7.69 GRMS, 20~2000 Hz/random (compliant with MIL-STD-810G)            |
|             | Non-operating | 4.02 GRMS, 15~2000 Hz/random (compliant with MIL-STD-810G)            |
| Shock       | Operating     | Acceleration, 50(G)/11(ms)/half sine (compliant with MIL-STD-202G)    |
|             | Non-operating | Acceleration, 1500(G)/0.5(ms)/half sine (compliant with MIL-STD-883K) |

Note: This Environmental Specification table indicates the conditions for testing the device. Real world usages may affect the results.

### 4.4 Mean Time Between Failures (MTBF)

Mean Time Between Failures (MTBF) is predicted based on reliability data for the individual components in SV250-M280. The prediction result for SV250-M280 is more than 3,000,000 hours.

Note: The MTBF is predicated and calculated based on “Telcordia Technologies Special Report, SR-332, Issue 3” method.

### 4.5 Certification and Compliance

SV250-M280 complies with the following standards:

- ANSI/ISA 71.04 G3
- CE
- UKCA
- FCC
- RoHS Recast
- MIL-STD-810G

## 4.6 Endurance

The endurance of a storage device is predicted by Drive Writes Per Day based on several factors related to usage, such as the amount of data written into the drive, block management conditions, and daily workload for the drive. Thus, key factors, such as Write Amplifications and the number of P/E cycles, can influence the lifespan of the drive.

**Table 4-4 Endurance Specifications**

| Capacity | Drive Writes Per Day |
|----------|----------------------|
| 30 GB    | 3.27                 |
| 60 GB    | 3.45                 |
| 120 GB   | 3.4                  |
| 240 GB   | 3.34                 |
| 480 GB   | 3.4                  |
| 960 GB   | 3.35                 |

Notes:

- This estimation complies with JEDEC JESD-219, Enterprise endurance workload of random data with payload size distribution.
- Flash vendor guaranteed 3D NAND TLC P/E cycle: 3K
- WAF may vary from capacity, flash configurations and writing behavior on each platform.
- 1 Terabyte = 1,024GB
- DWPD (Drive Writes Per Day) is calculated based on the number of times that user overwrites the entire capacity of an SSD per day of its lifetime during the warranty period. (3D NAND TLC warranty: 2 years)

## 4.7 LED Indicator Behavior

The behavior of the SV250-M280 LED indicators is described in Table 4-5.

**Table 4-5 LED Behavior**

| Location | LED   | Description                                 |
|----------|-------|---|
| LED A    | HDDA1 | LED blinks when the drive is being accessed |

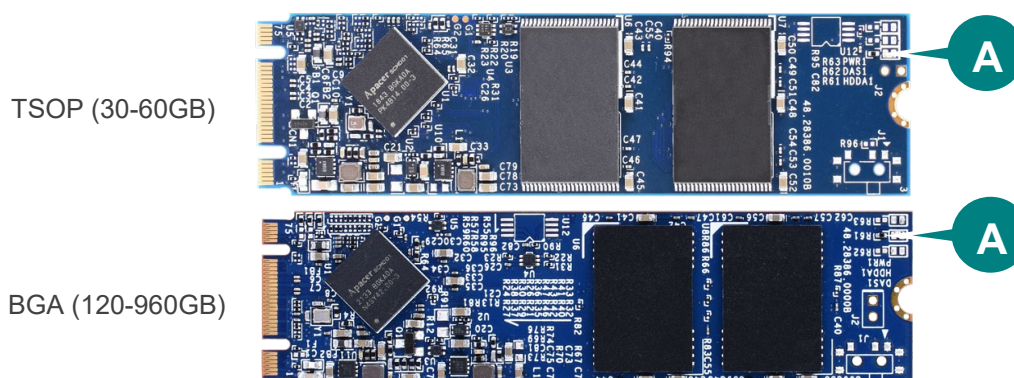

## 5. Flash Management

### 5.1 Error Correction/Detection

SV250-M280 implements a hardware ECC scheme, based on the Low Density Parity Check (LDPC). LDPC is a class of linear block error correcting code which has apparent coding gain over BCH code because LDPC code includes both hard decoding and soft decoding algorithms. With the error rate decreasing, LDPC can extend SSD endurance and increase data reliability while reading raw data inside a flash chip.

### 5.2 Bad Block Management

Current production technology is unable to guarantee total reliability of NAND flash memory array. When a flash memory device leaves factory, it comes with a minimal number of initial bad blocks during production or out-of-factory as there is no currently known technology that produce flash chips free of bad blocks. In addition, bad blocks may develop during program/erase cycles. Since bad blocks are inevitable, the solution is to keep them in control. Apacer flash devices are programmed with ECC, page mapping technique and S.M.A.R.T to reduce invalidity or error. Once bad blocks are detected, data in those blocks will be transferred to free blocks and error will be corrected by designated algorithms.

### 5.3 Global Wear Leveling

Flash memory devices differ from Hard Disk Drives (HDDs) in terms of how blocks are utilized. For HDDs, when a change is made to stored data, like erase or update, the controller mechanism on HDDs will perform overwrites on blocks. Unlike HDDs, flash blocks cannot be overwritten and each P/E cycle wears down the lifespan of blocks gradually. Repeatedly program/erase cycles performed on the same memory cells will eventually cause some blocks to age faster than others. This would bring flash storages to their end of service term sooner. Global wear leveling is an important mechanism that levels out the wearing of all blocks so that the wearing-down of all blocks can be almost evenly distributed. This will increase the lifespan of SSDs.

### 5.4 DataDefender™

Apacer's DataDefender is an advanced technology of power failure management which combines both firmware and hardware mechanisms to ensure data integrity. When power disruption occurs, the low voltage detector will be triggered. When this happens, the SSD's protection mechanism is activated and cuts off data transmission from the host. Once the power supply is resumed, the firmware protection mechanism will ensure the integrity of the firmware as well as the data already written into the NAND flash media.

### 5.5 ATA Secure Erase

ATA Secure Erase is an ATA disk purging command currently embedded in most of the storage drives. Defined in ATA specifications, (ATA) Secure Erase is part of Security Feature Set that allows storage drives to erase all user data areas. The erase process usually runs on the firmware level as most of the ATA-based storage media currently in the market are built-in with this command. ATA Secure Erase can securely wipe out the user data in the drive and protects it from malicious attack.

## 5.6 TRIM

TRIM is a SATA command that helps improve the read/write performance and efficiency of solid-state drives (SSD). The command enables the host operating system to inform SSD controller which blocks contain invalid data, mostly because of the erase commands from host. The invalid will be discarded permanently and the SSD will retain more space for itself.

## 5.7 Flash Translation Layer – Page Mapping

Page mapping is an advanced flash management technology whose essence lies in the ability to gather data, distribute the data into flash pages automatically, and then schedule the data to be evenly written. Page-level mapping uses one page as the unit of mapping. The most important characteristic is that each logical page can be mapped to any physical page on the flash memory device. This mapping algorithm allows different sizes of data to be written to a block as if the data is written to a data pool and it does not need to take extra operations to process a write command. Thus, page mapping is adopted to increase random access speed and improve SSD lifespan, reduce block erase frequency, and achieve optimized performance and lifespan.

## 5.8 Device Sleep (DevSleep or DEVSLP) Mode

Device Sleep is a feature that allows SATA devices to enter a low power mode by designating a particular pin as DEVSLP signal with an aim to reducing power consumption.

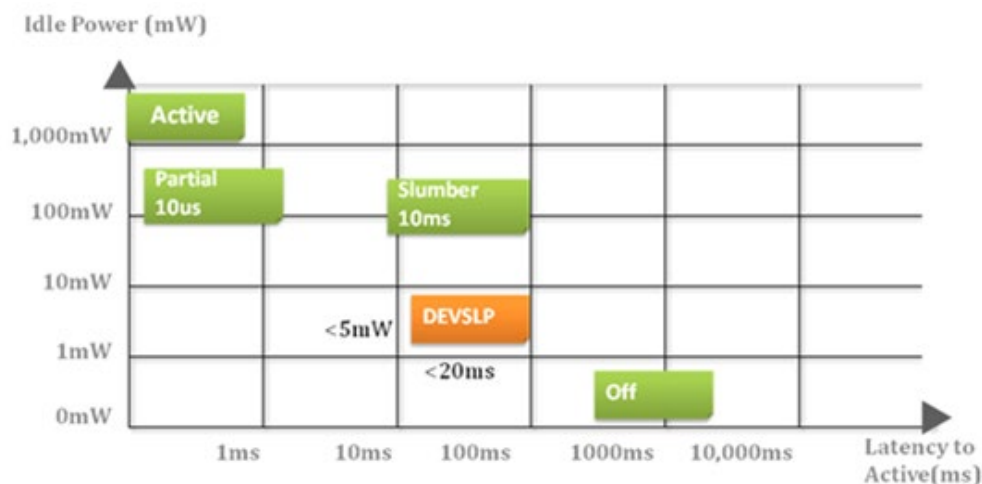

Figure 5-1 Device Sleep

## 5.9 Hyper Cache Technology

Apacer proprietary Hyper Cache technology uses a portion of the available capacity as SLC (1bit-per-cell) NAND flash memory, called Hyper cache mode. When data is written to SSD, the firmware will direct the data to Hyper Cache mode, providing excellent performance to handle various scenarios in industrial use.

## 5.10 Over-provisioning

Over-provisioning (OP) is a certain portion of the SSD capacity exclusively for increasing Garbage Collection (GC) efficiency, especially when the SSD is filled to full capacity or performs a heavy mixed-random workload. OP has the advantages of providing extended life expectancy, reliable data integrity, and high sustained write performance.

## 5.11 SATA Power Management

By complying with SATA 6 Gb/s specifications, the SSD supports the following SATA power saving modes:

- ACTIVE: PHY ready, full power, Tx & Rx operational
- PARTIAL: Reduces power, resumes in under 10  $\mu$ s (microseconds)
- SLUMBER: Reduces power, resumes in under 10 ms (milliseconds)
- HIPM: Host-Initiated Power Management
- DIPM: Device-Initiated Power Management
- AUTO-SLUMBER: Automatic transition from partial to slumber.
- Device Sleep (DevSleep or DEVSLP): PHY powered down; power consumption  $\leq$  5 mW; host assertion time  $\leq$  10 ms; exit timeout from this state  $\leq$  20 ms (unless specified otherwise in SATA Identify Device Log).

Note: The behaviors of power management features would depend on host/device settings.

## 5.12 DataRAID™

Apacer's DataRAID algorithm applies an additional level of protection and error-checking. Using this algorithm, a certain amount of space is given over to aggregating and resaving the existing parity data used for error checking. So, in the event that data becomes corrupted, the parity data can be compared to the existing uncorrupted data and the content of the corrupted data can be rebuilt.

## 5.13 SMART Read Refresh™

Apacer's SMART Read Refresh plays a proactive role in avoiding read disturb errors from occurring to ensure health status of all blocks of NAND flash. Developed for read-intensive applications in particular, SMART Read Refresh is employed to make sure that during read operations, when the read operation threshold is reached, the data is refreshed by re-writing it to a different block for subsequent use.

## 6. Security and Reliability Features

### 6.1 Anti-Sulfuration

Apacer's awarded patent for anti-sulfuration products adopts exclusive and improved alloy materials to protect silver in the electrode from reacting with sulfur to produce silver sulfide and cause an increase in resistance. This technology not only effectively solves corrosion problems caused by environmental pollution but also increases overall system lifespan and allows stable system operation over long hours in a harsh environment, ensuring product reliability and durability.

Apacer's anti-sulfuration SSDs achieve a complete air barrier through strict inspection of special materials and technologies. After two complete accelerated verification tests of MFG (Mixed Fluid Gas) and FoS (Flower of Sulfur), it has passed the American National Standards Institute/International Association of Automation 71.04 G3 air corrosion certification. This proves that it has reached the industry's highest level of sulfur resistance, including resistance to silver corrosion, copper corrosion and creep.

### 6.2 Advanced Encryption Standard

Advanced Encryption Standard (AES) is a specification for the encryption of electronic data. AES has been adopted by the U.S. government since 2001 to protect classified information and is now widely implemented in embedded computing applications. The AES algorithm used in software and hardware is symmetric so that encrypting/decrypting requires the same encryption key. Without the key, the encrypted data is inaccessible to ensure information security.

Notably in flash memory applications, AES 256-bit hardware encryption is the mainstream to protect sensitive or confidential data. The hardware encryption provides better performance, reliability, and security than software encryption. It uses a dedicated processor, which is built inside the controller, to process the encryption and decryption. This enormously shortens the processing time and makes it efficient.

### 6.3 End-to-End Data Protection

End-to-End Data Protection is a feature implemented in Apacer SSD products that extends error control to cover the entire path from the host computer to the drive and back, and ensure data integrity at multiple points in the path to enable reliable delivery of data transfers. Unlike ECC which does not exhibit the ability to determine the occurrence of errors throughout the process of data transmission, End-to-End Data Protection allows SSD controller to identify an error created anywhere in the path and report the error to the host computer before it is written to the drive. This error-checking and error-reporting mechanism therefore guarantees the trustworthiness and reliability of the SSD.

### 6.4 Thermal Sensor

Apacer Thermal Sensor is a digital temperature sensor with serial interface. By using a designated pin for transmission, storage device owners are able to read temperature data.

## 7. Software Interface

### 7.1 Command Set

This section defines the software requirements and the format of the commands the host sends to SV250-M280. Commands are issued to SV250-M280 by loading the required registers in the command block with the supplied parameters, and then writing the command code to the Command register.

Table 7-1 Command Set

| Code | Command                      | Code | Command                 |
|------|------------------------------|------|-------------------------|
| E5h  | CHECK POWER MODE             | F4h  | SECURITY ERASE UNIT     |
| 06h  | DATA SET MANAGEMENT          | F5h  | SECURITY FREEZE LOCK    |
| 92h  | DOWNLOAD MICROCODE           | F1h  | SECURITY SET PASSWORD   |
| 90h  | EXECUTE DEVICE DIAGNOSTIC    | F2h  | SECURITY UNLOCK         |
| E7h  | FLUSH CACHE                  | 70h  | SEEK                    |
| EAh  | FLUSH CACHE EXT              | EFh  | SET FEATURES            |
| ECh  | IDENTIFY DEVICE              | C6h  | SET MULTIPLE MODE       |
| E3h  | IDLE                         | E6h  | SLEEP                   |
| E1h  | IDLE IMMEDIATE               | B0h  | SMART                   |
| 91h  | INITIALIZE DEVICE PARAMETERS | E2h  | STANDBY                 |
| E4h  | READ BUFFER                  | E0h  | STANDBY IMMEDIATE       |
| C8h  | READ DMA                     | E8h  | WRITE BUFFER            |
| 25h  | READ DMA EXT                 | CAh  | WRITE DMA               |
| 60h  | READ FPDMA QUEUED            | 35h  | WRITE DMA EXT           |
| C4h  | READ MULTIPLE                | 3Dh  | WRITE DMA FUA EXT       |
| 29h  | READ MULTIPLE EXT            | 61h  | WRITE FPDMA QUEUED      |
| 2Fh  | READ LOG EXT                 | 3Fh  | WRITE LOG EXT           |
| 47h  | READ LOG DMA EXT             | 57h  | WRITE LOG DMA EXT       |
| 20h  | READ SECTOR                  | C5h  | WRITE MULTIPLE          |
| 24h  | READ SECTOR EXT              | 39h  | WRITE MULTIPLE EXT      |
| 40h  | READ VERIFY SECTORS          | CEh  | WRITE MULTIPLE FUA EXT  |
| 42h  | READ VERIFY SECTORS EXT      | 30h  | WRITE SECTOR            |
| 10h  | RECALIBRATE                  | 34h  | WRITE SECTOR EXT        |
| F6h  | SECURITY DISABLE PASSWORD    | 45h  | WRITE UNCORRECTABLE EXT |
| F3h  | SECURITY ERASE PREPARE       |      |                         |

## 7.2 S.M.A.R.T.

SMART, an acronym for Self-Monitoring, Analysis and Reporting Technology, is an open standard that allows a hard disk drive to automatically detect its health and report potential failures. When a failure is recorded by SMART, users can choose to replace the drive to prevent unexpected outage or data loss. Moreover, SMART can inform users of impending failures while there is still time to perform proactive actions, such as copy data to another device.

**Table 7-2 SMART Subcommand Set**

| Code | SMART Subcommand                  |
|------|-----------------------------------|
| D0h  | READ DATA                         |
| D1h  | READ ATTRIBUTE THRESHOLDS         |
| D2h  | ENABLE/DISABLE ATTRIBUTE AUTOSAVE |
| D4h  | EXECUTE OFF-LINE IMMEDIATE        |
| D5h  | SMART READ LOG                    |
| D6h  | SMART WRITE LOG                   |
| D8h  | ENABLE OPERATIONS                 |
| D9h  | DISABLE OPERATIONS                |
| DAh  | RETURN STATUS                     |

**Table 7-3 General SMART Attribute Structure**

| Byte  | Description |
|-------|-------------|
| 0     | ID (Hex)    |
| 1 – 2 | Status Flag |
| 3     | Value       |
| 4     | Worst       |
| 5*-11 | Raw Data    |

\*Byte 5: LSB

**Table 7-4 SMART Attribute ID List**

| ID (Hex)   | Attribute Name                     |
|------------|------------------------------------|
| 9 (0x09)   | Power-on Hours                     |
| 12 (0x0C)  | Power Cycle Count                  |
| 163 (0xA3) | Maximum Erase Count                |
| 164 (0xA4) | Average Erase Count                |
| 166 (0xA6) | Total Later Bad Block Count        |
| 167 (0xA7) | SSD Protect Mode (Vendor Specific) |
| 168 (0xA8) | SATA PHY Error Count               |
| 171 (0xAB) | Program Fail Count                 |
| 172 (0xAC) | Erase Fail Count                   |
| 175 (0xAF) | Bad Cluster Table Count            |
| 192 (0xC0) | Unexpected Power Loss Count        |
| 194 (0xC2) | Temperature                        |
| 231 (0xE7) | Lifetime Left                      |
| 241 (0xF1) | Total Sectors of Write             |

## 8. Electrical Specifications

### 8.1 Operating Voltage

Table 8-1 lists the supply voltage for SV250-M280.

**Table 8-1 Operating Range**

| Item           | Range                        |
|----------------|------------------------------|
| Supply Voltage | 3.3V $\pm$ 5% (3.135-3.465V) |

### 8.2 Power Consumption

Table 8-2 lists the power consumption for SV250-M280.

**Table 8-2 Power Consumption (Unit: mA)**

| Capacity<br>Mode     | 30 GB | 60 GB | 120 GB | 240 GB | 480 GB | 960 GB |
|----------------------|-------|-------|--------|--------|--------|--------|
| <b>Active (Max.)</b> | 270   | 340   | 415    | 405    | 420    | 450    |
| <b>Idle</b>          | 70    | 70    | 70     | 70     | 70     | 70     |

Notes:

- All values are typical and may vary depending on flash configurations or host system settings.
- Power consumption is measured using CrystalDiskMark 5.2.1.

## 9. Mechanical Specifications

### 9.1 TSOP Single Side (30-60GB)

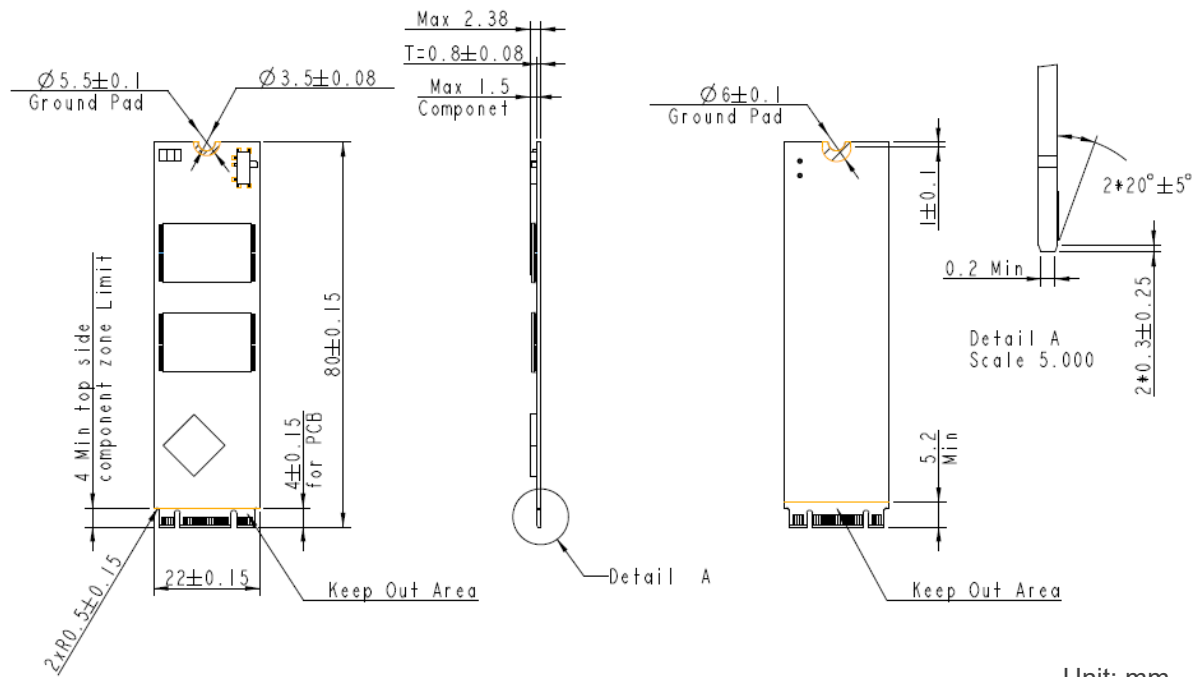

Figure 9-1 Dimensions – TSOP Single Side

## 9.2 BGA (120-960GB)

### 9.2.1 Single Side (120-480GB)

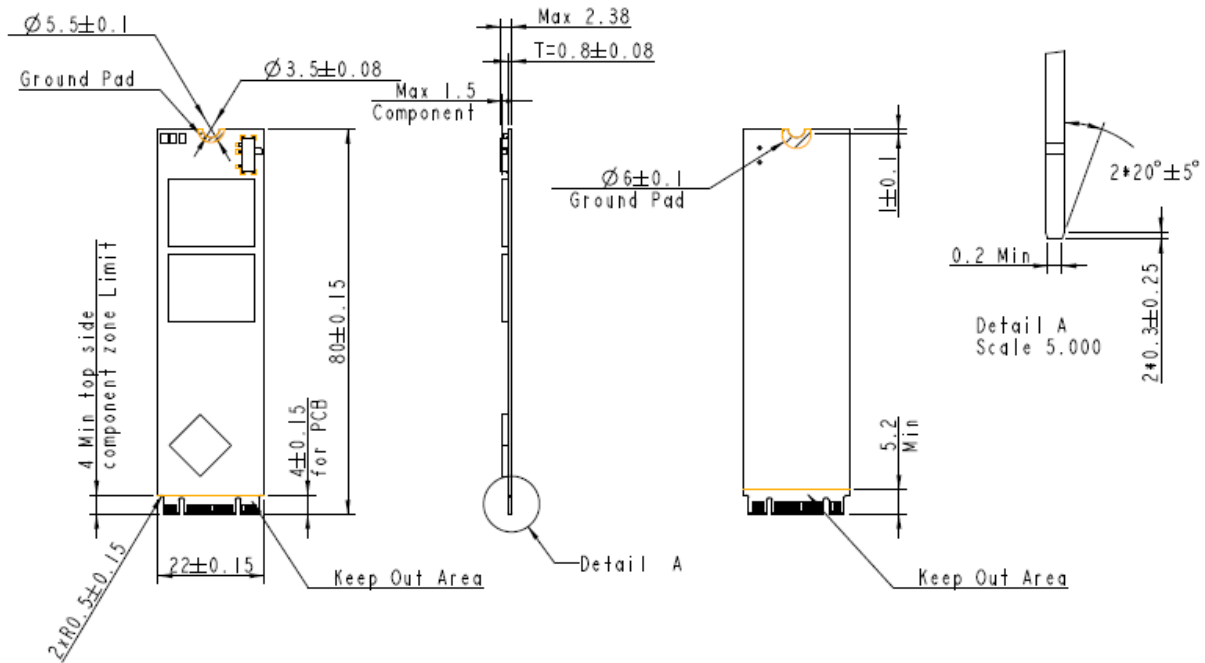

Figure 9-2 Dimensions – BGA Single Side

### 9.2.2 Double Side (960GB)

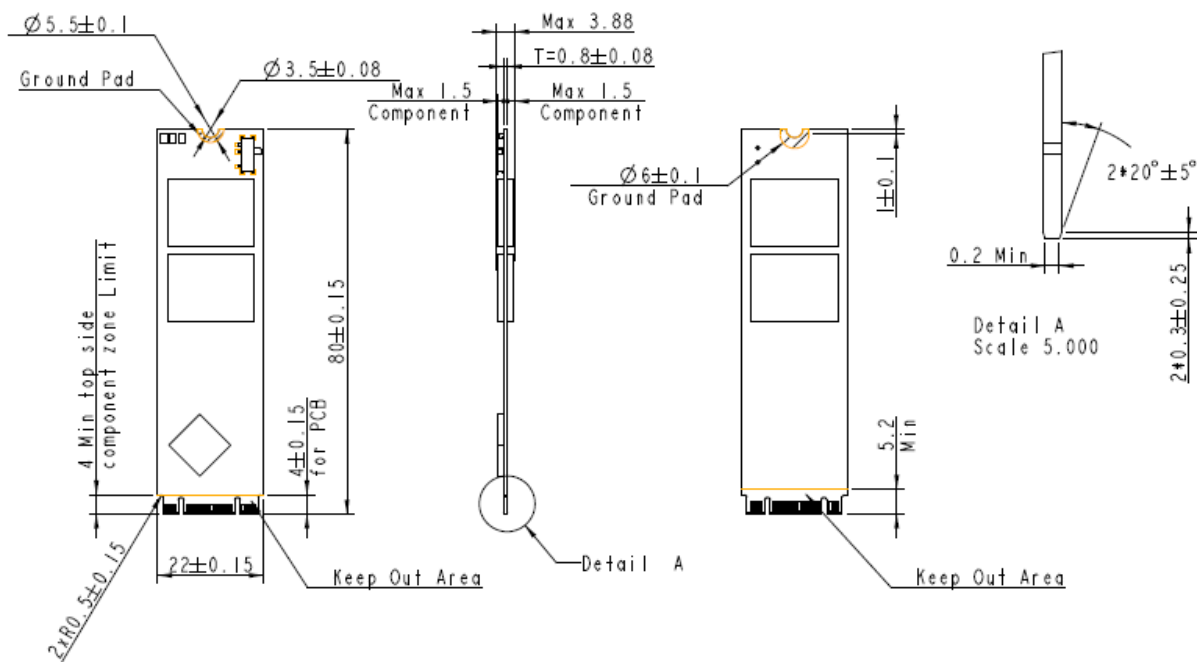

Figure 9-3 Dimensions – BGA Double Side

Unit: mm

## 9.3 Net Weight

Table 9-1 Net Weight

| Capacity | Net Weight (g $\pm$ 5%) |
|----------|-------------------------|
| 30GB     | 5.34                    |
| 60GB     | 5.83                    |
| 120GB    | 5.31                    |
| 240GB    | 5.31                    |
| 480GB    | 5.45                    |
| 960GB    | 6.48                    |

## 10. Product Ordering Information

### 10.1 Product Code Designations

Apacer's SV250-M280 SSD is available in different configurations and densities. See the chart below for a comprehensive list of options for the SV250-M280 series devices.

| Code | 1 | 2 | 3 | 4 | 5 | 6 | 7 | 8 | 9 | 10 | 11 | 12 | 13 | 14 | 15 | 16 |
|------|---|---|---|---|---|---|---|---|---|----|----|----|----|----|----|----|
|      | A | 5 | 2 | . | 2 | 5 | 5 | X | X | X  | .  | X  | X  | X  | 4  | 6  |

|  |  |
|--|--|
| <b>Code 1-3<br/>(Product Line &amp; Form Factor)</b> | SATA M.2 2280  |
| <b>Code 5-6<br/>(Model/Solution)</b>                 | SV250  |
| <b>Code 7-8<br/>(Product Capacity)</b>               | 5F: 30GB<br>5G: 60GB<br>5H: 120GB<br>5J: 240GB<br>5K: 480GB<br>5L: 960GB |
| <b>Code 9<br/>(Flash Type &amp; Product Temp)</b>    | G: 3D TLC Standard temperature<br>H: 3D TLC Wide temperature             |
| <b>Code 10<br/>(Product Spec)</b>                    | A: Single-sided B+M key<br>B: Double-sided B+M key                       |
| <b>Code 12-14<br/>(Version Number)</b>               | Random numbers generated by system                                       |
| <b>Code 15-16<br/>(Firmware Version)</b>             | Thermal Sensor with DEVSLP OP  |

## 10.2 Valid Combinations

The following table lists the available models of the SV250-M280 series which are in mass production or will be in mass production. Consult your Apacer sales representative to confirm availability of valid combinations and to determine availability of new combinations.

| Capacity | Standard Temperature | Wide Temperature |
|----------|----------------------|------------------|
| 30GB     | A52.255FGA.00246     | A52.255FHA.00246 |
| 60GB     | A52.255GGA.00346     | A52.255GHA.00246 |
| 120GB    | A52.255HGA.00446     | A52.255HHA.00246 |
| 240GB    | A52.255JGA.00546     | A52.255JHA.00246 |
| 480GB    | A52.255KGA.00346     | A52.255KHA.00246 |
| 960GB    | A52.255LGB.00446     | A52.255LHB.00246 |

## Revision History

| Revision | Description  | Date      |
|----------|--|-----------|
| 1.0      | Initial release  | 4/29/2021 |
| 1.1      | Updated product photo on the cover page and 4.7 LED Indicator Behavior | 4/20/2023 |

## Global Presence

### Taiwan (Headquarters)

#### Apacer Technology Inc.

1F., No.32, Zhongcheng Rd., Tucheng Dist.,  
New Taipei City 236, Taiwan R.O.C.  
Tel: 886-2-2267-8000  
Fax: 886-2-2267-2261  
[amtsales@apacer.com](mailto:amtsales@apacer.com)

### U.S.A.

#### Apacer Memory America, Inc.

46732 Lakeview Blvd., Fremont, CA 94538  
Tel: 1-408-518-8699  
Fax: 1-510-249-9551  
[sa@apacerus.com](mailto:sa@apacerus.com)

### Japan

#### Apacer Technology Corp.

6F, Daiyontamachi Bldg., 2-17-12, Shibaura, Minato-Ku,  
Tokyo, 108-0023, Japan  
Tel: 81-3-5419-2668  
Fax: 81-3-5419-0018  
[jpservices@apacer.com](mailto:jpservices@apacer.com)

### Europe

#### Apacer Technology B.V.

Science Park Eindhoven 5051 5692 EB Son,  
The Netherlands  
Tel: 31-40-267-0000  
Fax: 31-40-290-0686  
[sales@apacer.nl](mailto:sales@apacer.nl)

### China

#### Apacer Electronic (Shanghai) Co., Ltd

Room D, 22/FL, No.2, Lane 600, JieyunPlaza,  
Tianshan RD, Shanghai, 200051, China  
Tel: 86-21-6228-9939  
Fax: 86-21-6228-9936  
[sales@apacer.com.cn](mailto:sales@apacer.com.cn)

### India

#### Apacer Technologies Pvt Ltd,

1874, South End C Cross, 9<sup>th</sup> Block Jayanagar,  
Bangalore-560069, India  
Tel: 91-80-4152-9061/62  
Fax: 91-80-4170-0215  
[sales\\_india@apacer.com](mailto:sales_india@apacer.com)