

RoHS Recast Compliant

Serial ATA Flash Drive

SS210-M280 Product Specifications

November 3, 2017

Version 1.0



Apacer Technology Inc.

1F, No.32, Zhongcheng Rd., Tucheng Dist., New Taipei City, Taiwan, R.O.C

Tel: +886-2-2267-8000 Fax: +886-2-2267-2261

www.apacer.com

Features:

- **Standard SATA Interface Compliance**
 - Serial ATA Revision 3.2 compliance
 - SATA 6.0 Gbps interface
 - ATA-8 command set
- **Capacity**
 - 16, 32 GB
- **Performance***
 - Burst read/write: 600 MB/sec
 - Sequential read: Up to 530 MB/sec
 - Sequential write: Up to 245 MB/sec
 - Seq. read QD32: Up to 555 MB/sec
 - Seq. write QD32: Up to 250 MB/sec
 - Random read (4K): Up to 78,000 IOPS
 - Random write (4K): Up to 62,000 IOPS
- **Flash Management**
 - Built-in hardware ECC
 - Global Wear Leveling
 - Flash bad-block management
 - S.M.A.R.T.
 - Power Failure Management
 - ATA Secure Erase
 - TRIM
- **NAND Flash Type: SLC**
- **MTBF: >2,000,000 hours**
- **Temperature Range**
 - Operating: -40°C to 85°C
 - Storage: -40°C to 85°C
- **Supply Voltage**
 - 3.3 V \pm 5%
- **Power Consumption***
 - Active mode: 425 mA
 - Idle mode: 75 mA
- **Connector Type**
 - 75-pin SATA-based M.2 module pinout
- **Form Factor**
 - M.2 2280 form factor
 - Dimensions: 80.00 x 22.00 x 1.50, unit: mm
- **Shock & Vibration****
 - Shock: 1,500 G
 - Vibration: 15 G
- **DRAM Cache for Enhanced Random Performance**
- **Device Sleep**
- **RoHS Recast Compliant (Complies with 2011/65/EU Standard)**

*Varies from capacities. The values for performances and power consumptions presented are typical and may vary depending on flash configurations or platform settings. The term idle refers to the standby state of the device.

**Non-operating

Table of Contents

1. General Descriptions	3
2. Pin Assignments.....	4
3. Product Specifications.....	7
3.1 Capacity.....	7
3.2 Performance	7
3.3 Environmental Specifications	8
3.4 Mean Time Between Failures (MTBF)	8
3.5 Certification and Compliance	8
4. Flash Management.....	9
4.1 Error Correction/Detection.....	9
4.2 Bad Block Management	9
4.3 Global Wear Leveling	9
4.4 Power Failure Management	9
4.5 ATA Secure Erase.....	9
4.6 TRIM.....	10
4.7 SATA Power Management.....	10
4.8 DEVSLP (DevSleep or DEVSLP) Mode.....	11
5. Software Interface	12
5.1 Command Set.....	12
5.2 S.M.A.R.T.	12
6. Electrical Specifications	14
6.1 Operating Voltage.....	14
6.2 Power Consumption	14
7. Physical Characteristics.....	15
7.1 Dimensions.....	15
8. Product Ordering Information.....	17
8.1 Product Code Designations.....	17
8.2 Valid Combinations.....	18

1. General Descriptions

Apacer's SS210-M280 is the next generation modularized Solid State Drive (SSD) with the shape of all new M.2 form factor, aimed to be the more suitable for mobile and compact computers with standard width at only 22.00 mm. SS210-M280 appears in M.2 2280 mechanical dimensions and is believed to be the leading add-in storage solution for future host computing systems.

The M.2 SSD is designed with SATA-based connector pinouts, providing full compliance with the latest SATA Revision 3.2 interface specifications. Aside from SATA compliance, SS210-M280 delivers exceptional performance and power efficiency. On the other hand, the extreme thin and light form factor makes SS210-M280 the ideal choice for mobile computing systems, which appears to be the trend in near future.

Regarding reliability, SS210-M280 is built with a powerful SATA controller that supports on-the-module ECC as well as efficient wear leveling scheme. In terms of power efficiency, SS210-M280 is compliant with SATA 6.0 Gbps interface standard so that it can operate on SATA power management modes, which greatly save on power consumption.

2. Pin Assignments

This connector does not support hot plug capability. There are a total of 75 pins. 12 pin locations are used for mechanical key locations; this allows such a module to plug into both Key B and Key M connectors.

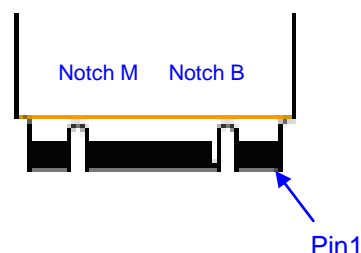

Table 2-1 Pin Assignments

Pin	Type	Description
1	CONFIG_3	Ground (according to M.2 configurations for SSD-SATA definition)
2	3.3V	Supply Pin, 3.3V
3	GND	Ground
4	3.3V	Supply pin, 3.3V
5	No connect	No connect
6	Not available	No connect (used for other purposes)
7	Not available	No connect (used for other purposes)
8	Not available	No connect (used for other purposes)
9	No connect	No connect
10	DAS/DSS	Device Activity Signal/Disable Staggered Spin-up
11	No connect	No connect (used for other purposes)
12	(removed for key)	Mechanical notch B
13	(removed for key)	Mechanical notch B
14	(removed for key)	Mechanical notch B
15	(removed for key)	Mechanical notch B
16	(removed for key)	Mechanical notch B
17	(removed for key)	Mechanical notch B
18	(removed for key)	Mechanical notch B
19	(removed for key)	Mechanical notch B
20	Not available	No connect (used for other purposes)
21	CONFIG_0	Ground (according to M.2 configurations for SSD-SATA definition)
22	Not available	No connect (used for other purposes)
23	Not available	No connect (used for other purposes)
24	Not available	No connect (used for other purposes)
25	Not available	No connect (used for other purposes)
26	Not available	No connect (used for other purposes)
27	GND	Ground
28	Not available	No connect (used for other purposes)
29	PERn1	Not used
30	Not available	No connect (used for other purposes)
31	PERp1	Not used
32	Not available	No connect (used for other purposes)
33	GND	Ground
34	Not available	No connect (used for other purposes)
35	PETn1	Not used
36	Not available	No connect (used for other purposes)
37	PETp1	Not used

Table 2-1 Pin Assignments

Pin	Type	Description
38	DEVSLP	Device Sleep, input. If driven high the host is informing the SSD to enter a low power state
39	GND	Ground
40	Not available	No connect (used for other purposes)
41	SATA-Rx+	Host receiver differential signal pair
42	Not available	No connect (used for other purposes)
43	SATA-Rx-	Host receiver differential signal pair
44	Not available	No connect (used for other purposes)
45	GND	Ground
46	Not available	No connect (used for other purposes)
47	SATA-Tx-	Host transmitter differential pair
48	Not available	No connect (used for other purposes)
49	SATA-Tx+	Host transmitter differential pair
50	PERST#	Not used
51	GND	Ground
52	CLKREQ#	Not used
53	REFCLKN	Not used
54	PEWAKE#	Not used
55	REFCLKP	Not used
56	MFG1	Manufacturing pin. Use determined by vendor (no connect on a host)
57	GND	Ground
58	MFG2	Manufacturing pin. Use determined by vendor (no connect on a host)
59	(removed for key)	Mechanical notch M
60	(removed for key)	Mechanical notch M
61	(removed for key)	Mechanical notch M
62	(removed for key)	Mechanical notch M
63	(removed for key)	Mechanical notch M
64	(removed for key)	Mechanical notch M
65	(removed for key)	Mechanical notch M
66	(removed for key)	Mechanical notch M
67	Not available	No connect (used for other purposes)
68	SUSCLK	Not used
69	CONFIG_1	Ground
70	3.3V	Supply pin, 3.3V
71	GND	Ground
72	3.3V	Supply pin, 3.3V
73	GND	Ground
74	3.3V	Supply pin, 3.3V
75	CONFIG_2	Ground

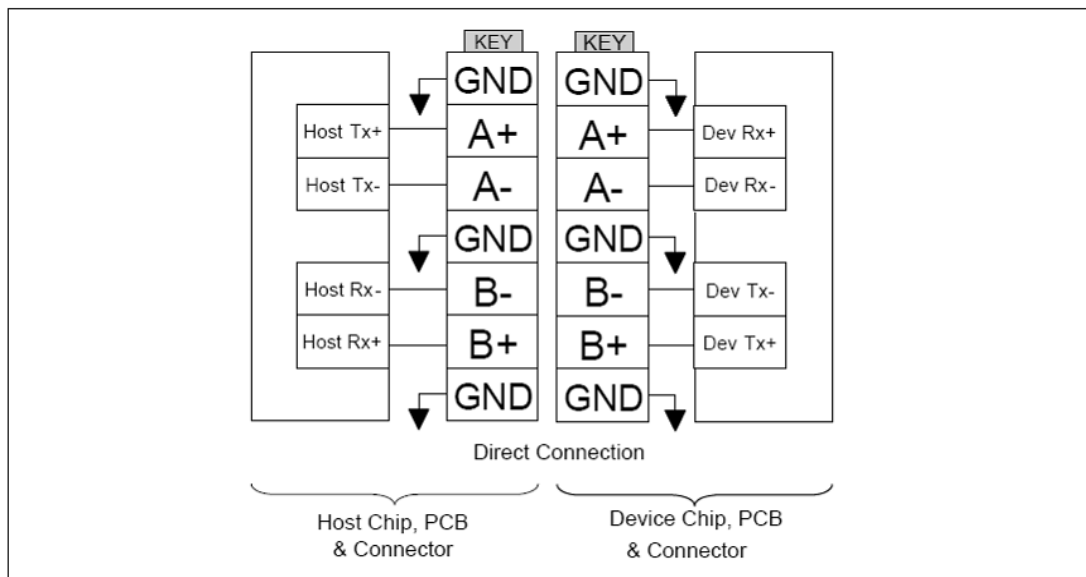

Figure 2-1 Direct Connection between the Host and Device

3. Product Specifications

3.1 Capacity

Capacity specifications of SS210-M280 are available as shown in Table 3-1. It lists the specific capacity and the default numbers of heads, sectors and cylinders for each product line.

Table 3-1 Capacity Specifications

Capacity	Total bytes*	Cylinders	Heads	Sectors	Max LBA
16 GB	16,013,942,784	16,383	16	63	31,277,232
32 GB	32,017,047,552	16,383	16	63	62,533,296

*Display of total bytes varies from file systems, which means not all of the bytes can be used for storage.

**Notes: 1 GB = 1,000,000,000 bytes; 1 sector = 512 bytes.

LBA count addressed in the table above indicates total user storage capacity and will remain the same throughout the lifespan of the device. However, the total usable capacity of the SSD is most likely to be less than the total physical capacity because a small portion of the capacity is reserved for device maintenance usages.

3.2 Performance

Performance of SS210-M280 is listed below in Table 3-2.

Table 3-2 Performance Specifications

Capacity	16 GB	32 GB
Performance		
Sequential Read* (MB/s)	315	530
Sequential Write* (MB/s)	135	245
Seq. Read QD32* (MB/s)	330	555
Seq. Write QD32* (MB/s)	135	250
Random Read IOPS** (4K)	62,000	78,000
Random Write IOPS** (4K)	25,000	62,000

Note:

Results may differ from various flash configurations or host system setting.

*Sequential performance is based on CrystalDiskMark 5.2.1 with file size 1,000MB.

**Random performance measured using IOMeter with Queue Depth 32.

3.3 Environmental Specifications

Environmental specifications of SS210-M280 product are shown in Table 3-3.

Table 3-3 Environmental Specifications

Item	Specifications
Operating temperature	-40°C to 85°C
Non-operating temperature	-40°C to 85°C
Vibration (Non-operating)	Frequency/Displacement: 20Hz~80Hz/1.52mm Frequency/Acceleration: 80Hz~2000Hz/20G X, Y, Z axis/60mins
Shock (Non-operating)	1,500G, 0.5ms
Drop (Non-operating)	80cm free fall, 6 face of each unit
Bending (non-operating)	≥ 20N, hold 1min/5times
Torque (non-operating)	0.5N-m or ±2.5 deg, hold 1min/5times
ESD (Electrostatic)	Passed (at relative temp/humidity: 24°C, 49%RH)

3.4 Mean Time Between Failures (MTBF)

Mean Time Between Failures (MTBF) is predicted based on reliability data for the individual components in SS210-M280. The prediction result for SS210-M280 is more than 2,000,000 hours.

Note: The MTBF is predicated and calculated based on “Telcordia Technologies Special Report, SR-332, Issue 2” method.

3.5 Certification and Compliance

SS210-M280 complies with the following standards:

- CE: EN55022
- FCC: CISPR22
- BSMI 13438
- RoHS Recast

4. Flash Management

4.1 Error Correction/Detection

SS210-M280 implements a hardware ECC scheme, based on the BCH algorithm. It can detect and correct up to 72 bits error in 1K bytes.

4.2 Bad Block Management

Current production technology is unable to guarantee total reliability of NAND flash memory array. When a flash memory device leaves factory, it comes with a minimal number of initial bad blocks during production or out-of-factory as there is no currently known technology that produce flash chips free of bad blocks. In addition, bad blocks may develop during program/erase cycles. When host performs program/erase command on a block, bad block may appear in Status Register. Since bad blocks are inevitable, the solution is to keep them in control. Apacer flash devices are programmed with ECC, page mapping technique and S.M.A.R.T to reduce invalidity or error. Once bad blocks are detected, data in those blocks will be transferred to free blocks and error will be corrected by designated algorithms.

4.3 Global Wear Leveling

Flash memory devices differ from Hard Disk Drives (HDDs) in terms of how blocks are utilized. For HDDs, when a change is made to stored data, like erase or update, the controller mechanism on HDDs will perform overwrites on blocks. Unlike HDDs, flash blocks cannot be overwritten and each P/E cycle wears down the lifespan of blocks gradually. Repeatedly program/erase cycles performed on the same memory cells will eventually cause some blocks to age faster than others. This would bring flash storages to their end of service term sooner. Global wear leveling is an important mechanism that levels out the wearing of all blocks so that the wearing-down of all blocks can be almost evenly distributed. This will increase the lifespan of SSDs.

4.4 Power Failure Management

Power Failure Management plays a crucial role when experiencing unstable power supply. Power disruption may occur when users are storing data into the SSD. In this urgent situation, the controller would run multiple write-to-flash cycles to store the metadata for later block rebuilding. This urgent operation requires about several milliseconds to get it done. At the next power up, the firmware will perform a status tracking to retrieve the mapping table and resume previously programmed NAND blocks to check if there is any incompleteness of transmission.

Note: The controller unit of this product model is designed with a DRAM as a write cache for improved performance and data efficiency. Though unlikely to happen in most cases, the data cached in the volatile DRAM might be potentially affected if a sudden power loss takes place before the cached data is flushed into non-volatile NAND flash memory.

4.5 ATA Secure Erase

ATA Secure Erase is an ATA disk purging command currently embedded in most of the storage drives. Defined in ATA specifications, (ATA) Secure Erase is part of Security Feature Set that allows storage drives to erase all user data areas. The erase process usually runs on the firmware level as most of the ATA-based storage media currently in the market are built-in with this command. ATA Secure Erase can securely wipe out the user data in the drive and protects it from malicious attack.

4.6 TRIM

TRIM, though in capital letters usually, is a memory computation command rather than an abbreviation. It is mainly a SATA command that enables the operating system to inform the SSD (Solid State Drive) which blocks of previously stored data are no longer valid, due to erases by the host or operating system, such as file deletions or disk formatting. Once notified, SSD will begin the discard of the invalid LBAs and retain more space for itself, in fact, the discarded is no longer recoverable.

When an LBA is replaced by the operating system, as with overwrite of a file, the SSD is informed that the originally occupied LBA is determined as no longer in use or invalid. The SSD will not save those blocks in garbage collected sectors. Noticeably, a file deletion command by host or operating system never actually erases the actual content, but marks the file as deleted. This issue is even specifically noticeable for flash based memory devices, such as SSDs. In fact, an SSD will keep garbage collecting the invalid, previously occupied LBAs, if it is not informed that these LBAs can be erased. Thus, the SSD would experience a significant performance downfall.

4.7 SATA Power Management

By complying with SATA 6.0 Gb/s specifications, the SSD supports the following SATA power saving modes:

- ACTIVE: PHY ready, full power, Tx & Rx operational
- PARTIAL: Reduces power, resumes in under 10 μ s (microseconds)
- SLUMBER: Reduces power, resumes in under 10 ms (milliseconds)
- HIPM: Host-Initiated Power Management
- DIPM: Device-Initiated Power Management
- AUTO-SLUMBER: Automatic transition from partial to slumber.
- Device Sleep (DevSleep or DEVSLP): PHY powered down; power consumption \leq 5 mW; host assertion time \leq 10 ms; exit timeout from this state \leq 20 ms (unless specified otherwise in SATA Identify Device Log).

Note: The behaviors of power management features would depend on host/device settings.

4.8 DEVSLP (DevSleep or DEVSLP) Mode

Device Sleep is a feature that allows SATA devices to enter a low power mode by designating pin 44 as DEVSLP signal with an aim to reducing power consumption.

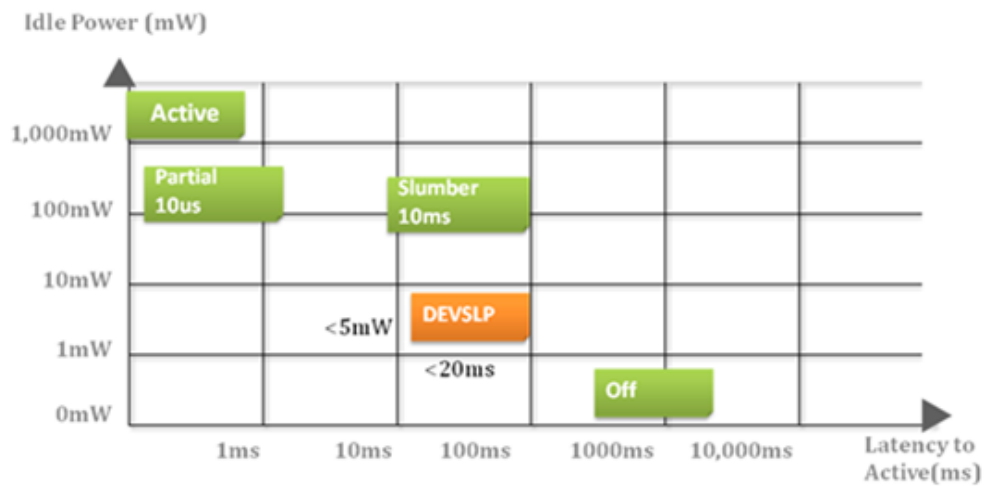

5. Software Interface

5.1 Command Set

Table 5-1 Command Set

Code	Command	Code	Command
E5h	Check Power Mode	F3h	Security Erase Prepare
06h	Data Set Management	F4h	Security Erase Unit
90h	Execute Device Diagnostic	F5h	Security Freeze Lock
E7h	Flush Cache	F1h	Security Set Password
EAh	Flush Cache EXT	F2h	Security Unlock
ECh	Identify Device	70h	Seek
E3h	Idle	EFh	Set Features
E1h	Idle Immediate	C6h	Set Multiple Mode
91h	Initialize Device Parameters	E6h	Sleep
C8h	Read DMA	B0h	SMART
25h	Read DMA EXT	E2h	Standby
C4h	Read Multiple	E0h	Standby Immediate
29h	Read Multiple EXT	CAh	Write DMA
20h	Read Sector	35h	Write DMA EXT
24h	Read Sector EXT	C5h	Write Multiple
40h	Read Verify Sectors	39h	Write Multiple EXT
42h	Read Verify Sectors EXT	30h	Write Sector
10h	Recalibrate	34h	Write Sector EXT
F6h	Security Disable Password		

5.2 S.M.A.R.T.

S.M.A.R.T. is an abbreviation for Self-Monitoring, Analysis and Reporting Technology, a self-monitoring system that provides indicators of drive health as well as potential disk problems. It serves as a warning for users from unscheduled downtime by monitoring and displaying critical drive information. Ideally, this should allow taking proactive actions to prevent drive failure and make use of S.M.A.R.T. information for future product development reference.

Apacer devices use the standard SMART command B0h to read data out from the drive to activate our S.M.A.R.T. feature that complies with the ATA/ATAPI specifications. S.M.A.R.T. Attribute IDs shall include initial bad block count, total later bad block count, maximum erase count, average erase count, power on hours and power cycle. When the S.M.A.R.T. Utility running on the host, it analyzes and reports the disk status to the host before the device reaches in critical condition.

Note: Attribute IDs may vary from product models due to various solution design and supporting capabilities.

Apacer memory products come with S.M.A.R.T. commands and subcommands for users to obtain information of drive status and to predict potential drive failures. Users can take advantage of the following commands/subcommands to monitor the health of the drive.

Code	SMART Subcommand
D0h	READ DATA
D1h	READ ATTRIBUTE THRESHOLDS
D2h	Enable/Disable Attribute Autosave
D4h	Execute Off-line Immediate
D5h	Read Log (optional)
D6h	Write Log (optional)
D8h	Enable Operations
D9h	Disable operations
DAh	Return Status

General SMART attribute structure

Byte	Description
0	ID (Hex)
1 – 2	Status flag
3	Value
4	Worst
5*-11	Raw Data

*Byte 5: LSB

SMART attribute ID list

ID (Hex)	Attribute Name
9 (0x09)	Power-on hours
12 (0x0C)	Power cycle count
163 (0xA3)	Max. erase count
164 (0xA4)	Avg. erase count
166 (0xA6)	Total later bad block count
167 (0xA7)	SSD Protect Mode (vendor specific)
168 (0xA8)	SATA PHY Error Count
175 (0xAF)	Bad Cluster Table Count
192 (0xC0)	Unexpected Power Loss Count
194 (0xC2)	Temperature
241 (0xF1)	Total sectors of write

6. Electrical Specifications

6.1 Operating Voltage

Table 6-1 lists the supply voltage for SS210-M280.

Table 6-1 Operating Range

Item	Range
Supply Voltage	3.3V \pm 5% (3.135-3.465V)

6.2 Power Consumption

Table 6-2 lists the power consumption for SS210-M280.

Table 6-2 Power Consumption

Mode \ Capacity	16 GB	32 GB
Active (mA)	325	425
Idle (mA)	75	75

Note:

*All values are typical and may vary depending on flash configurations or host system settings.

**Active power is an average power measurement performed using CrystalDiskMark with 128KB sequential read/write transfers.

7. Physical Characteristics

7.1 Dimensions

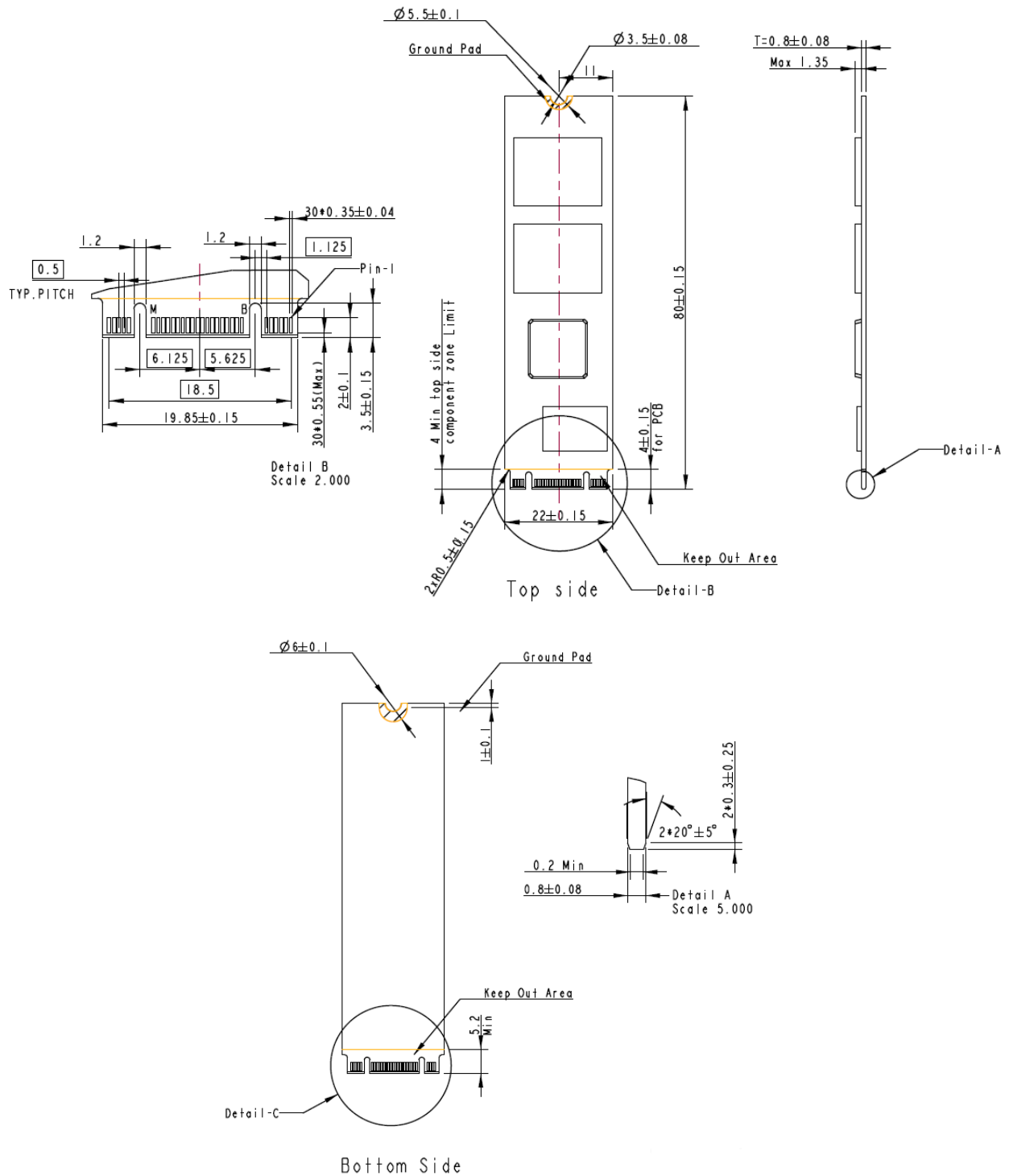

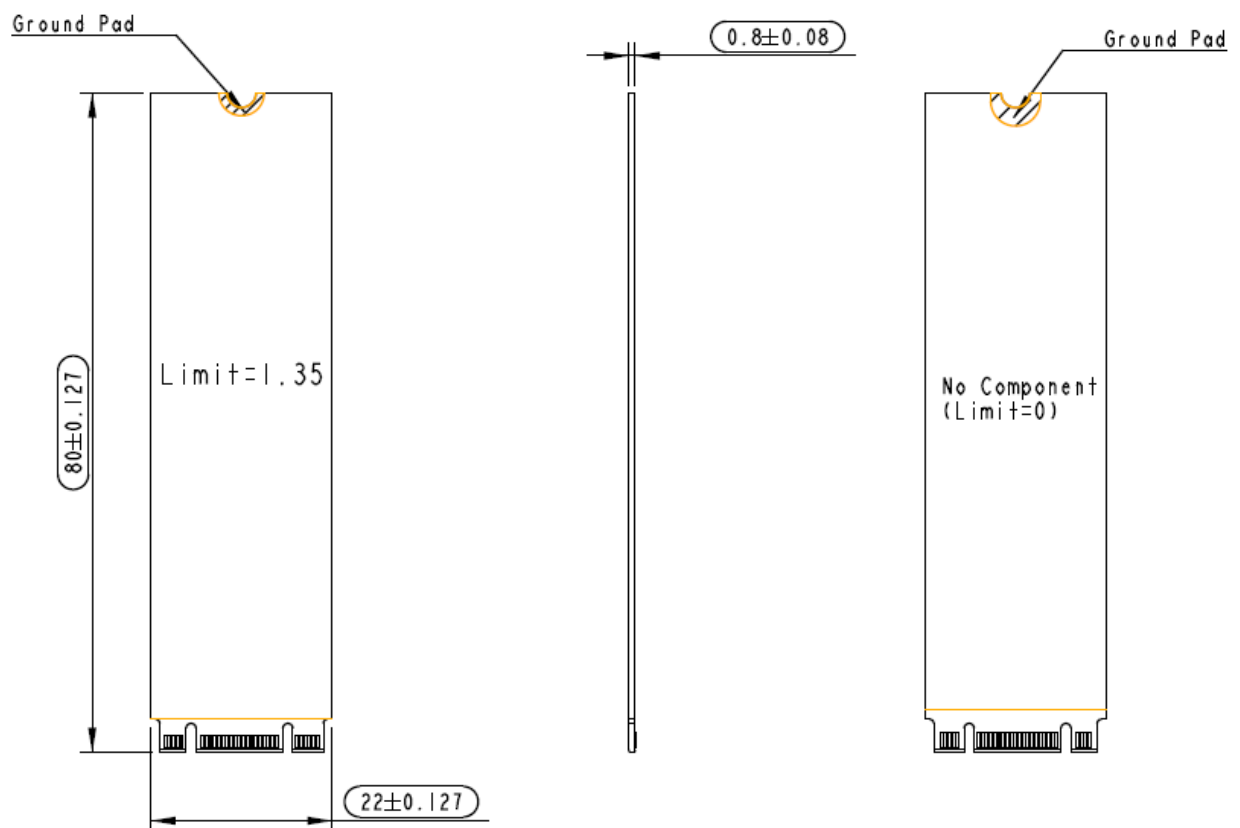
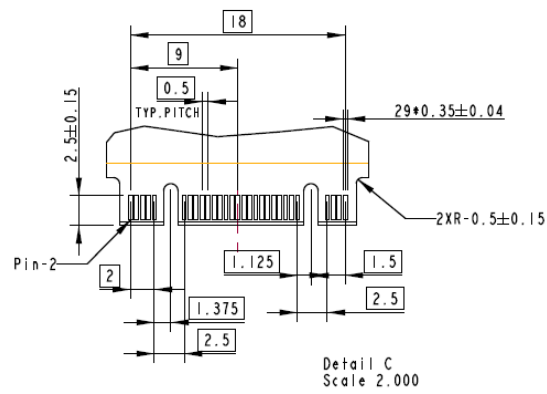

8. Product Ordering Information

8.1 Product Code Designations

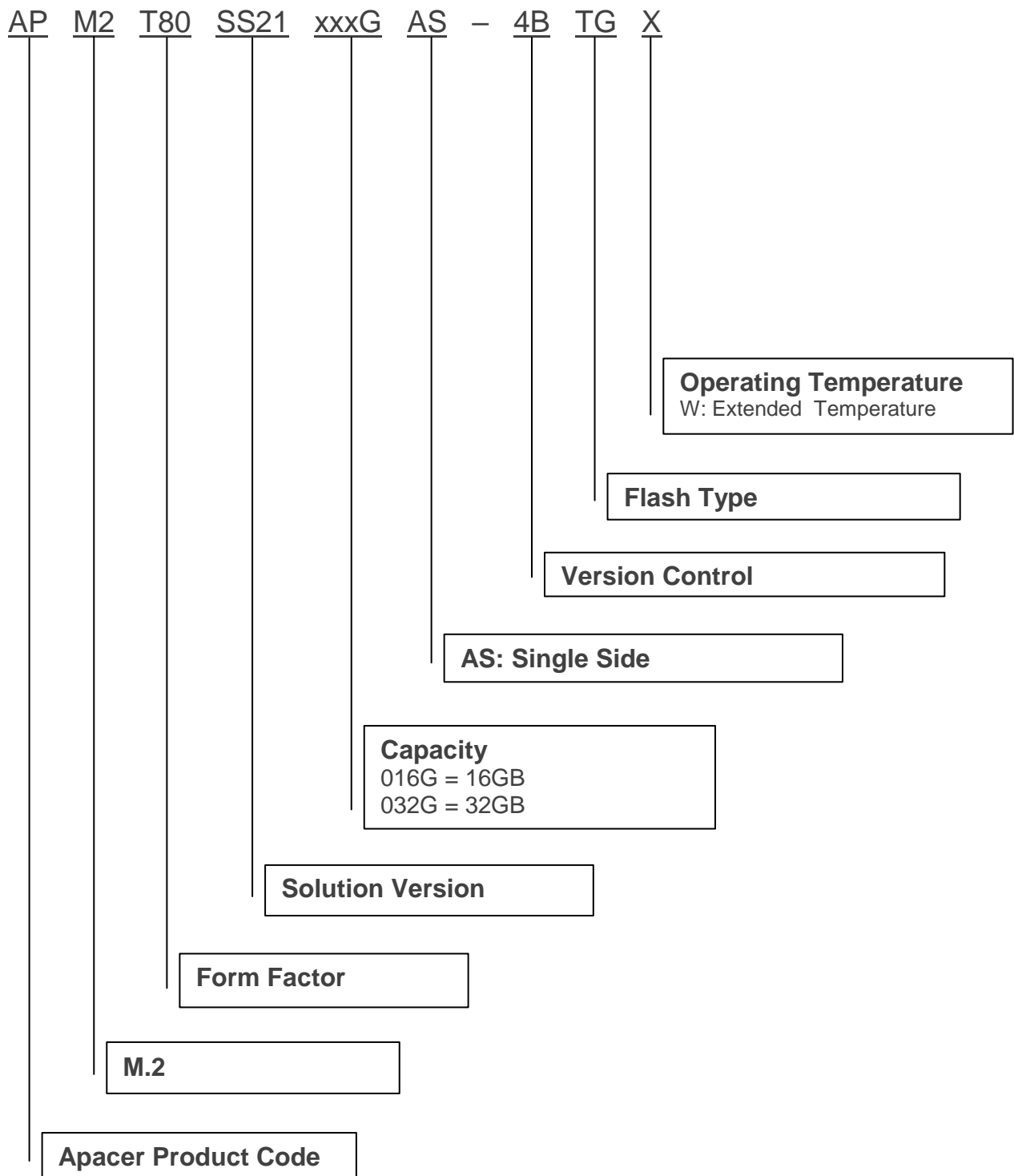

8.2 Valid Combinations

Capacity	Standard Temperature
16GB	APM2T80SS21016GAS-4BTGW
32GB	APM2T80SS21032GAS-4BTGW

Note: Valid combinations are those products in mass production or will be in mass production. Consult your Apacer sales representative to confirm availability of valid combinations and to determine availability of new combinations.

Revision History

Revision	Description	Date
1.0	Official release	11/3/2017

Global Presence

Taiwan (Headquarters)

Apacer Technology Inc.

1F., No.32, Zhongcheng Rd., Tucheng Dist.,
New Taipei City 236, Taiwan R.O.C.
Tel: 886-2-2267-8000
Fax: 886-2-2267-2261
amtsales@apacer.com

U.S.A.

Apacer Memory America, Inc.

46732 Lakeview Blvd., Fremont, CA 94538
Tel: 1-408-518-8699
Fax: 1-510-249-9551
sa@apacerus.com

Japan

Apacer Technology Corp.

5F, Matsura Bldg., Shiba, Minato-Ku
Tokyo, 105-0014, Japan
Tel: 81-3-5419-2668
Fax: 81-3-5419-0018
jpservices@apacer.com

Europe

Apacer Technology B.V.

Science Park Eindhoven 5051 5692 EB Son,
The Netherlands
Tel: 31-40-267-0000
Fax: 31-40-290-0686
sales@apacer.nl

China

Apacer Electronic (Shanghai) Co., Ltd

Room D, 22/FL, No.2, Lane 600, JieyunPlaza,
Tianshan RD, Shanghai, 200051, China
Tel: 86-21-6228-9939
Fax: 86-21-6228-9936
sales@apacer.com.cn

India

Apacer Technologies Pvt Ltd,

Unit No.201, "Brigade Corner", 7th Block
Jayanagar,
Yediyur Circle, Bangalore – 560082, India
Tel: 91-80-4152-9061
Fax: 91-80-4170-0215
sales_india@apacer.com