



FCC SDoC Test Report

Issued date: Sep. 20, 2023

Project No.: 23Q090603

Product : SATA Flash Drive

Model : SV250-7LP3, SX250-7LP3 (X=A~Z)

Applicant : Apacer Technology Inc.

Address : 1F., No.32, Zhongcheng Rd., Tucheng Dist., New Taipei City 236,
Taiwan (R.O.C)

Report No: WD-EF-R-230285-A0

According to

47 CFR FCC Part 15, Subpart B, Class B

ANSI C63.4: 2014

ANSI C63.4a: 2017

Authorized Signatory :  / Ken Huang



Wendell Industrial Co., Ltd
Wendell EMC & RF Laboratory

Add: 5F-1, No. 188, Baoqiao Road, Xindian District, New Taipei City 23145, Taiwan R.O.C.



Table of Contents

1	Certification	5
1.1	Summary of Test Result.....	6
2	Test Configuration of Equipment Under Test	7
2.1	Test Facility.....	7
2.2	Measurement Uncertainty	8
2.2.1	Conducted Emission test.....	8
2.2.2	Radiated Emission test.....	8
3	General Information.....	9
3.1	Description of EUT.....	9
3.2	Description of Test Modes.....	10
3.3	EUT Operating Condition	10
3.4	Description of Support Unit	11
3.5	Configuration of System Under Test.....	11
4	Emission Test.....	12
4.1	Conducted Emission Measurement	12
4.1.1	Limit of Conducted Emission Measurement	12
4.1.2	Test Instrument	13
4.1.3	Test Procedure.....	14
4.1.4	Deviation from Test Standard	14
4.1.5	Test Setup.....	15
4.1.6	Test Result	16
4.1.7	Photographs of Test Configuration	18
4.2	Radiated Emission Measurement	19
4.2.1	Limits of Radiated Emission Measurement	19
4.2.2	Test Instrument	21
4.2.3	Test Procedure.....	22
4.2.4	Deviation from Test Standard	22
4.2.5	Test Setup.....	23
4.2.6	Test Result	24
4.2.7	Photographs of Test Configuration	28



History of this test report

Report No.	Issue date	Description
WD-EF-R-230285-A0	Sep. 20, 2023	Initial Issue

Declaration

This report is for your exclusive use. Any copying or replication of this report to or for any other person or entity, or use of our name or trademark, is permitted only with our prior written permission. This report sets forth our findings solely with respect to the test samples identified herein. The results set forth in this report are not indicative or representative of the quality or characteristics of the lot from which a test sample was taken or any similar or identical product unless specifically and expressly noted. Our report includes all of the tests requested by you and the results thereof based upon the information that you provided to us.



History of supplementary report

Report No.	Issue date	Description
WD-EF-R-230285-A0	Sep. 20, 2023	Original report

Declaration

This report is for your exclusive use. Any copying or replication of this report to or for any other person or entity, or use of our name or trademark, is permitted only with our prior written permission. This report sets forth our findings solely with respect to the test samples identified herein. The results set forth in this report are not indicative or representative of the quality or characteristics of the lot from which a test sample was taken or any similar or identical product unless specifically and expressly noted. Our report includes all of the tests requested by you and the results thereof based upon the information that you provided to us.



1 Certification

Product: SATA Flash Drive

Brand Name: Apacer

Model: SV250-7LP3, SX250-7LP3 (X=A~Z)

Applicant: Apacer Technology Inc.

Tested: Sep. 08 ~ Sep. 11, 2023

Standard: 47 CFR FCC Part 15, Subpart B, Class B

ANSI C63.4: 2014

ANSI C63.4a: 2017

The above equipment (Model: SV250-7LP3) has been tested by **Wendell EMC & RF Laboratory**, and found compliance with the requirement of the above standards. The test record, data evaluation and Equipment Under Test (EUT) configurations represented herein are true and accurate accounts of the measurements of the sample's EMC characteristics under the conditions specified in this report.

Please note that the measurement uncertainty are provided for informational purpose only and are not used in determining the Pass/Fail results.



1.1 Summary of Test Result

The EUT has been tested according to the following specifications:

Emission				
Standard	Test Item	Limit	Result	Remark
47 CFR FCC Part 15, Subpart B	Conducted disturbance at mains terminals	Class B	Pass	Meets the requirements
	Radiated disturbance	Class B	Pass	Meets the requirements

Note: Test record contained in the referenced test report relate only to the EUT sample and test item.



2 Test Configuration of Equipment Under Test

2.1 Test Facility

FCC Designation / Registration Number:

W01: TW1117 / 831863

W08: TW1122 / 763672

Conducted disturbance at mains terminals Test

W01: 5F-1, No.188, Baoqiao Rd., Xindian Dist., New Taipei City 23145, Taiwan (R.O.C)

Conducted disturbance at mains terminals and Radiated emission (9*6*6 Chamber) Tests

W08: No.119, Wugong 3rd Rd., Wugu Dist., New Taipei City 248, Taiwan (R.O.C)

ACCREDITATIONS

The laboratories are accredited and approved by the TAF according to ISO/IEC 17025.

2.2 Measurement Uncertainty

The measurement instrumentation uncertainty is evaluated according to CISPR 16-4-2.

This uncertainty represents an expanded uncertainty expressed at approximately the 95% confidence level using a coverage factor of $k=2$.

Wendell EMC & RF Laboratory U_{lab} is less than U_{cispr} , therefore compliance or non-compliance with a disturbance limit shall be determined in the following manner.

- compliance is deemed to occur if no measured disturbance level exceeds the disturbance limit;
- non-compliance is deemed to occur if any measured disturbance level exceeds the disturbance limit.

Please note that the measurement uncertainty (U_{lab}) is provided for informational purpose only and is not used in determining the Pass/Fail results.

2.2.1 Conducted Emission test

Test Site	Measurement Freq. Range	dB (U_{lab})	Note
W01-CE	150 kHz ~ 30 MHz	2.75	N/A
W08-CE	150 kHz ~ 30 MHz	2.76	N/A

2.2.2 Radiated Emission test

Test Site	Measurement Freq. Range	Ant	dB (U_{lab})	Note
W08-966-1	30 MHz ~ 200 MHz	V	3.78	N/A
	30 MHz ~ 200 MHz	H	2.69	N/A
	200 MHz ~ 1000 MHz	V	4.91	N/A
	200 MHz ~ 1000 MHz	H	3.40	N/A
	1 GHz ~ 6 GHz	V	4.48	N/A
	1 GHz ~ 6 GHz	H	4.33	N/A
	6 GHz ~ 18 GHz	V	4.56	N/A
	6 GHz ~ 18 GHz	H	4.56	N/A
	18 GHz ~ 40 GHz	V	4.42	N/A
	18 GHz ~ 40 GHz	H	4.42	N/A



3 General Information

3.1 Description of EUT

Product	SATA Flash Drive
Brand	Apacer
Model	SV250-7LP3, SX250-7LP3 (X=A~Z)
Applicant	Apacer Technology Inc.
Received Date	Sep. 07, 2023
EUT Power Rating	5Vdc (from host equipment)
Model Differences	The models are electrically identical, different models no. are for marketing purpose. The series model information is provided by client.
Operating System	N/A
Data Cable Supplied	N/A
Accessory Device	N/A
I/O Port	Please refer to the User's Manual

Note:

1. The EUT's highest operating frequency is 12MHz. Therefore the radiated emission is tested up to 6GHz.

3.2 Description of Test Modes

Test results are presented in the report as below.

Test Mode	Test Condition
Conducted emission test	
-	Normal mode
Radiated emission 30MHz ~ 1GHz test	
-	Normal mode
Radiated emission above 1GHz test	
-	Normal mode

3.3 EUT Operating Condition

- a. Inserted the EUT into PC and placed on test table.
- b. The PC read and write data with EUT.
- c. The PC run test program “BurnIN.exe” to enable all functions.
- d. The PC sent “H” message to monitor and displayed on screen.
- e. The microphone sent voice signal to PC.
- f. The PC sent voice signal to earphone.

3.4 Description of Support Unit

The EUT has been conducted testing with other necessary accessories or support units.

Item	Equipment	Brand	Model No.	Serial No.	FCC ID	Data Cable	Power Cable	Remark
1	Desktop PC	DELL	D19M	N/A	PPD-QCN FA335	N/A	1.8m non-shielded cable	-
2	4K Monitor	HP	HP 27f 4k Display	3CM01916T F	FCC DoC Approved	1.5m shielded HDMI cable with 2 cores	AC: 1.8m non-shielded cable DC: 1.4m non-shielded cable with 1 core	-
3	Keyboard	DELL	KB216t	CN-0W33XP -L0300-7C1- 15UP	FCC DoC Approved	1.5m non-shielded cable	N/A	-
4	Mouse	DELL	MS116	CN-0DV0RH -L0300-7C1- 15UP	FCC DoC Approved	1.5m non-shielded cable	N/A	-
5	Earphone & Microphone	E-books	E-EPA057	N/A	N/A	1.4m non-shielded cable	N/A	-

Note: 1. The core(s) is(are) originally attached to the cable(s).

3.5 Configuration of System Under Test

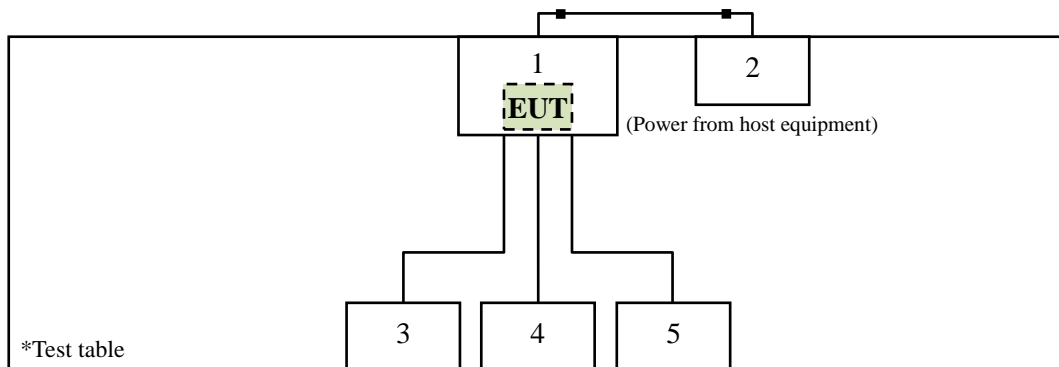



4 Emission Test

4.1 Conducted Emission Measurement

4.1.1 Limit of Conducted Emission Measurement

Frequency (MHz)	Class A (dB μ V)		Class B (dB μ V)	
	Quasi-peak (dB μ V)	Average (dB μ V)	Quasi-peak (dB μ V)	Average (dB μ V)
0.15 - 0.5	79	66	66 to 56	56 to 46
0.5 - 5	73	60	56	46
5 - 30	73	60	60	50

- Note:**
1. The lower limit shall apply at the transition frequencies.
 2. The limit decreases in line with the logarithm of the frequency in the range of 0.15 to 0.50 MHz.
 3. Detector function in the form: PK = Peak, QP = Quasi Peak, AV = Average
 4. The test result calculated as following:
Measurement Value = Reading Level + Correct Factor
Correction Factor = Insertion loss of LISN + Cable loss + Transient Limiter (If use)
Margin Level = Measurement Value – Limit Value



4.1.2 Test Instrument

Test Site: W01-CE					
Item	Equipment	Manufacturer	Model	Meter No.	Calibration Date
1	TWO-LINE V-NETWORK	R&S	ENV216	CT-1-025-1	Jun. 09, 2023
2	Pulse limiter	R&S	ESH3-Z2	CT-2-015	Jun. 01, 2023
3	EMI Test Receiver	R&S	ESCI	CT-1-024	May 30, 2023
4	Artificial Mains Network (AMN)	SCHWARZBECK	NSLK 8127	CT-1-104-1	Jun. 09, 2023
5	RF Cable	MVE	200200.400LL .500A	CT-9-101	Jun. 01, 2023
6	50ohm Termination	N/A	N/A	CT-1-065-1	Jun. 12, 2023
7	Measurement Software	EZ-EMC	Ver: EMC-CON 3A1	CT-3-012	No calibration request

Note: 1. The calibration interval of the above test instruments is 12 months.

Test Site: W08-CE					
Item	Equipment	Manufacturer	Model	Meter No.	Calibration Date
1	TWO-LINE V-NETWORK	R&S	ENV216	CT-1-025-2	Jun. 16, 2023
2	RF Cable	EMCI	EMCCFD300-BM-BM-5000	CT-1-107-2	Jun. 17, 2023
3	EMI Test Receiver	R&S	ESR3	CT-1-103	Jun. 19, 2023
4	Artificial Mains Network (AMN)	SCHWARZBECK	NSLK 8127 RC	CT-1-104-1RC	Jun. 16, 2023
5	Transient Limiter	Electro-Metrics	EM-7600	CT-1-026	Jun. 17, 2023
6	50ohm Termination	N/A	N/A	CT-1-109-1	Jun. 16, 2023
7	Measurement Software	EZ-EMC	Ver: EMC-CON 3A1	CT-3-012	No calibration request

Note: 1. The calibration interval of the above test instruments is 12 months.

4.1.3 Test Procedure

- a. The table-top EUT was placed 0.8 meter height wooden table from the horizontal ground plane with EUT being connected to power source through a line impedance stabilization network (LISN). The LISN at least be 80 cm from nearest chassis of EUT. The floor-standing EUT and all cables shall be insulated from the ground plane by up to 12 mm of insulating material if required.
- b. The line impedance stabilization network (LISN) provides 50 ohm/50uH of coupling impedance for the measuring instrument. All other support equipments powered from additional LISN(s).
- c. Interrelating cables that hang closer than 40 cm to the ground plane shall be folded back and forth in the center forming a bundle. All I/O cables were positioned to simulate typical usage.
- d. All I/O cables that are not connected to a peripheral shall be bundle in the center. The end of the cable may be terminated, if required, using the correct terminating impedance. The overall length shall not exceed 1 m.
- e. The EMI test receiver connected to LISN powering the EUT. The actual test configuration, please refer to EUT test photos.
- f. The receiver scanned from 150kHz to 30MHz for emissions in each of test modes. A scan was taken on both power lines, Line and Neutral, recording at least six highest emissions.
- g. The EUT and cable configuration of the above highest emission levels were recorded. The test data of the worst case was recorded.

4.1.4 Deviation from Test Standard

No deviation

4.1.5 Test Setup

< Table-Top equipment >

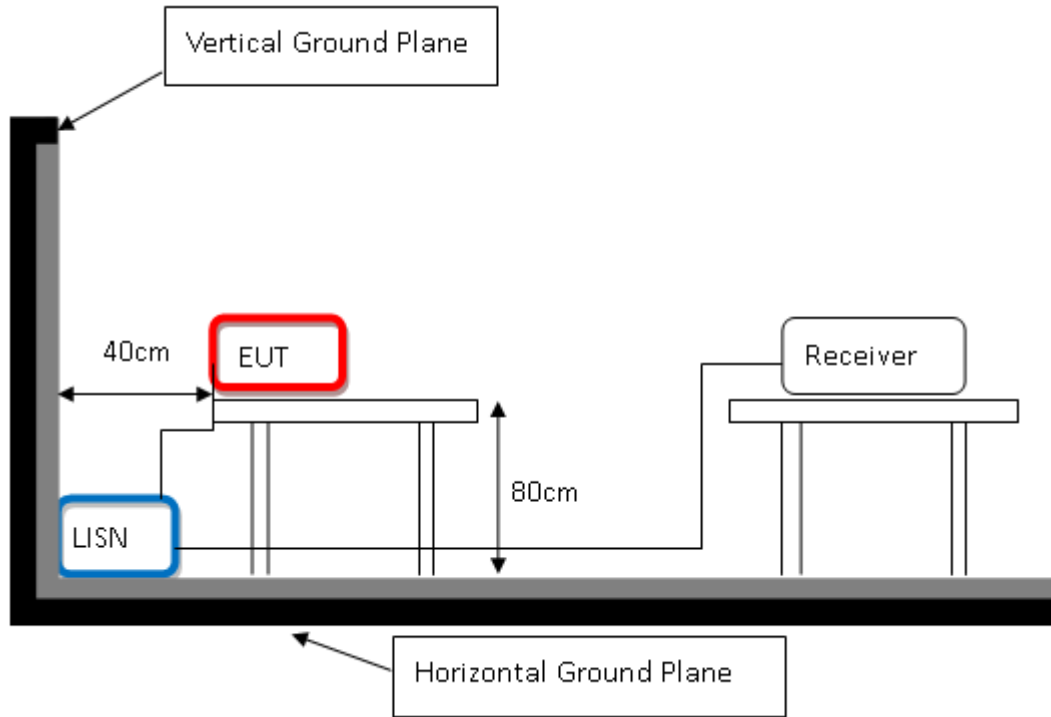

< Floor-Standing equipment >

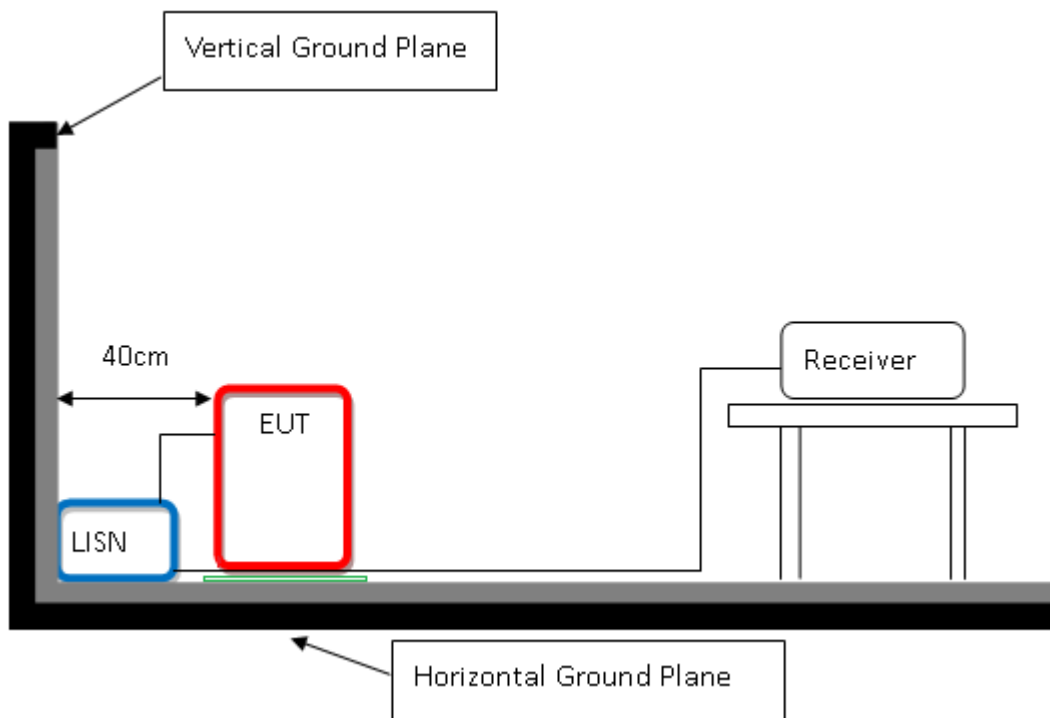

Note: Please refer to 4.1.7 for the actual test configuration.



4.1.6 Test Result

Test Voltage	120Vac, 60Hz	Frequency Range	0.15-30 MHz
Environmental Conditions	23°C, 52% RH	6dB Bandwidth	9 kHz
Test Date	2023/09/08	Phase	L
Tested by	Guanwei Liao	Test Site	W01-CE

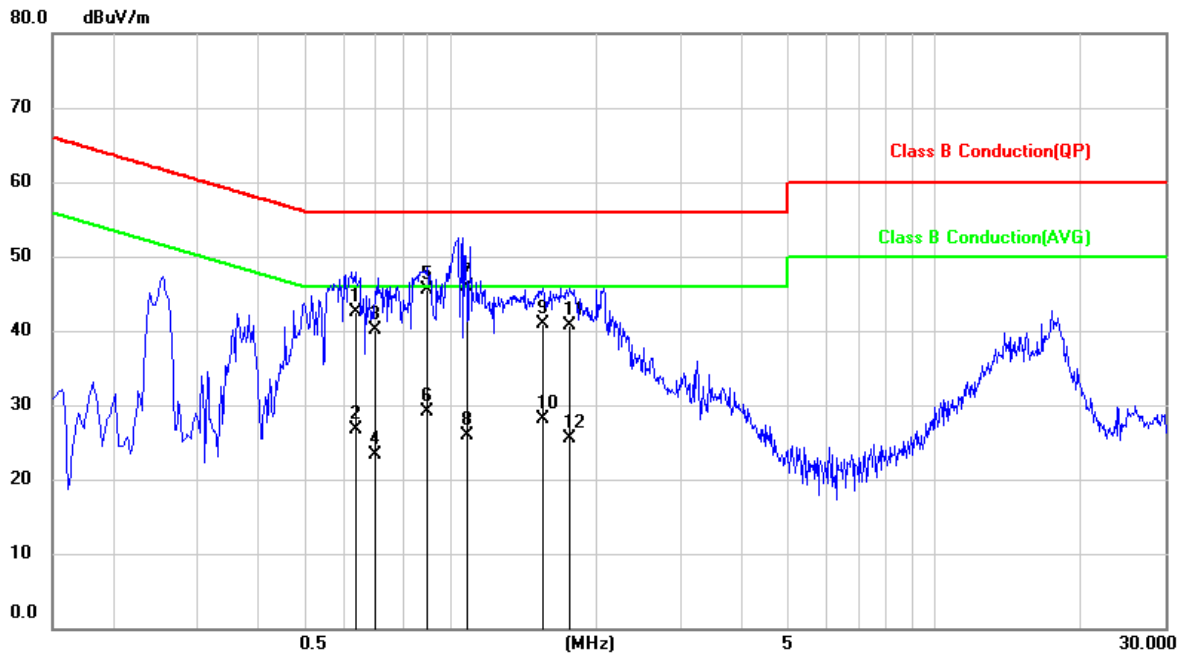

No.	Frequency (MHz)	Reading Level (dBμV)	Correct Factor (dB)	Measurement (dBμV)	Limit (dBμV)	Margin (dB)	Detector
1	0.6351	32.47	9.95	42.42	56.00	-13.58	QP
2	0.6351	16.70	9.95	26.65	46.00	-19.35	AVG
3	0.6968	30.22	9.95	40.17	56.00	-15.83	QP
4	0.6968	13.26	9.95	23.21	46.00	-22.79	AVG
5	0.8942	35.49	9.97	45.46	56.00	-10.54	QP
6	0.8942	19.16	9.97	29.13	46.00	-16.87	AVG
7	1.0851	35.89	9.97	45.86	56.00	-10.14	QP
8	1.0851	16.00	9.97	25.97	46.00	-20.03	AVG
9	1.5580	30.91	10.01	40.92	56.00	-15.08	QP
10	1.5580	18.18	10.01	28.19	46.00	-17.81	AVG
11	1.7643	30.62	10.01	40.63	56.00	-15.37	QP
12	1.7643	15.52	10.01	25.53	46.00	-20.47	AVG

Remark: 1. QP = Quasi Peak, AVG = Average
 2. Correction Factor = Insertion loss of LISN + Cable loss + Transient Limiter (If use)
 3. Measurement Value = Reading Level + Correct Factor
 4. Margin Level = Measurement Value - Limit Value



Test Voltage	120Vac, 60Hz	Frequency Range	0.15-30 MHz
Environmental Conditions	23°C, 52% RH	6dB Bandwidth	9 kHz
Test Date	2023/09/08	Phase	N
Tested by	Guanwei Liao	Test Site	W01-CE

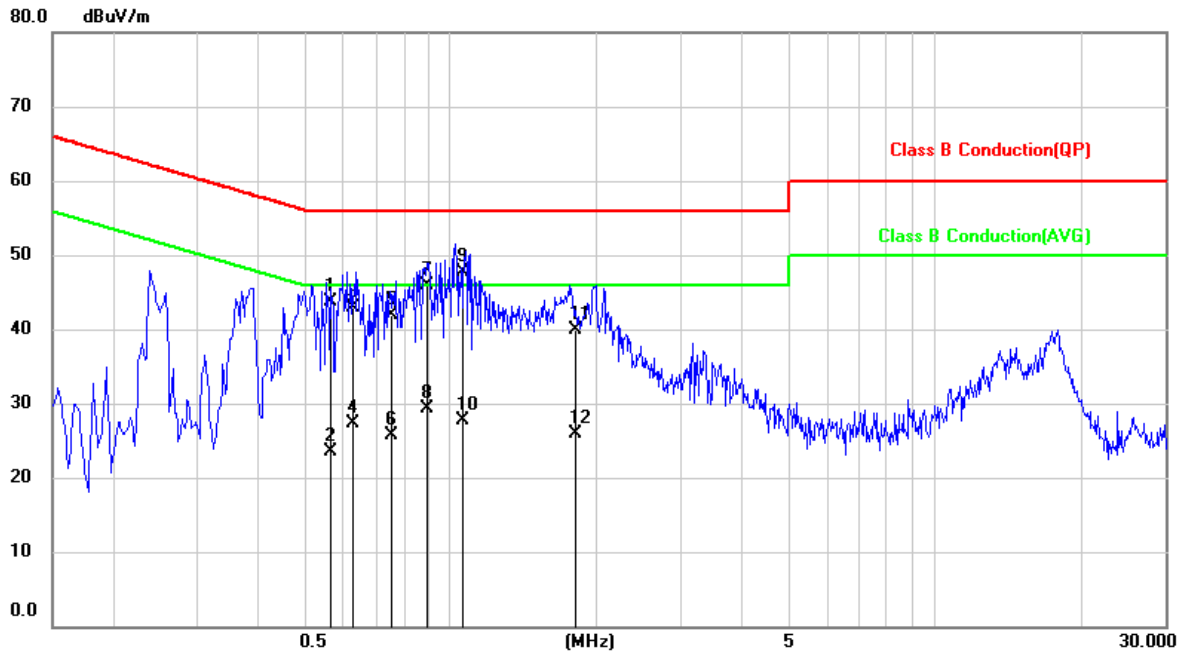

No.	Frequency (MHz)	Reading Level (dBμV)	Correct Factor (dB)	Measurement (dBμV)	Limit (dBμV)	Margin (dB)	Detector
1	0.5692	33.64	9.97	43.61	56.00	-12.39	QP
2	0.5692	13.50	9.97	23.47	46.00	-22.53	AVG
3	0.6289	32.85	9.97	42.82	56.00	-13.18	QP
4	0.6289	17.36	9.97	27.33	46.00	-18.67	AVG
5	0.7611	31.83	9.99	41.82	56.00	-14.18	QP
6	0.7611	15.71	9.99	25.70	46.00	-20.30	AVG
7	0.8976	35.84	9.99	45.83	56.00	-10.17	QP
8	0.8976	19.32	9.99	29.31	46.00	-16.69	AVG
9	1.0582	37.80	9.99	47.79	56.00	-8.21	QP
10	1.0582	17.63	9.99	27.62	46.00	-18.38	AVG
11	1.8080	29.88	10.03	39.91	56.00	-16.09	QP
12	1.8080	15.89	10.03	25.92	46.00	-20.08	AVG

Remark: 1. QP = Quasi Peak, AVG = Average
 2. Correction Factor = Insertion loss of LISN + Cable loss + Transient Limiter (If use)
 3. Measurement Value = Reading Level + Correct Factor
 4. Margin Level = Measurement Value - Limit Value

4.1.7 Photographs of Test Configuration

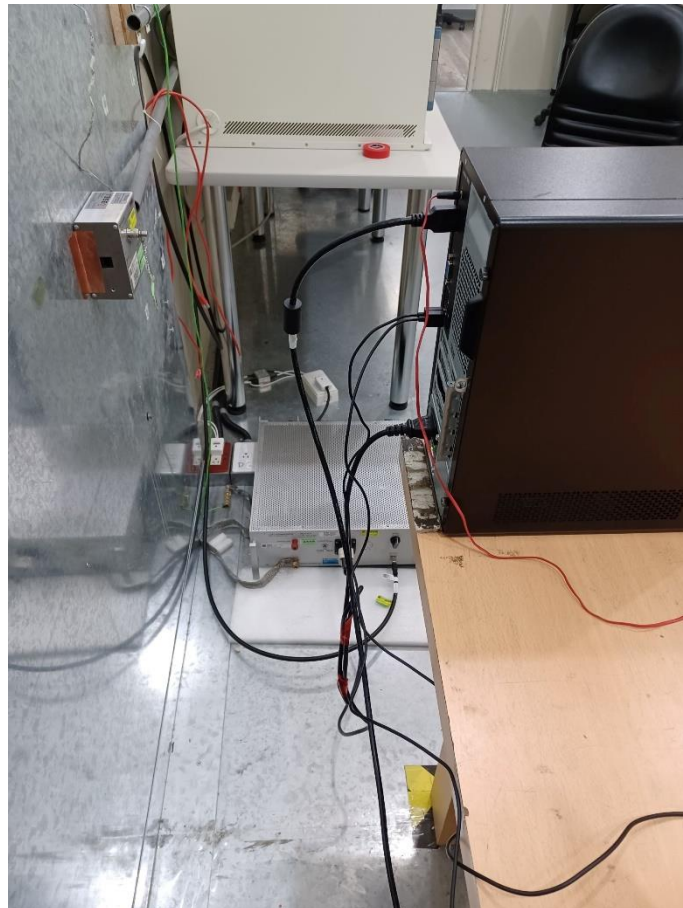



4.2 Radiated Emission Measurement

4.2.1 Limits of Radiated Emission Measurement

Radiated Frequency range 30 MHz to 1000 MHz

FCC 15B Radiated Emissions Limits				
Frequency range (MHz)	Class A (3m) Quasi-peak (dB μ V/m)	Class A (10m) Quasi-peak (dB μ V/m)	Class B (3m) Quasi-peak (dB μ V/m)	Class B (10m) Quasi-peak (dB μ V/m)
30 - 88	49.5	39.1	40	29.5
88 - 216	54	43.5	43.5	33.1
216 - 230	56.9	46.4	46	35.6
230 - 960				
960 - 1000	60	49.5	54	43.5

- Note:**
1. The lower limit shall apply at the transition frequency.
 2. Detector function in the form: PK = Peak, QP = Quasi Peak, AV = Average
 3. The test result calculated as following:
 Measurement Value = Reading Level + Correct Factor
 Correction Factor = Antenna factor + Cable loss (Antenna to preamplifier) - preamplifier Gain
 + Cable loss (preamplifier to receiver)
 Margin Level = Measurement Value - Limit Value

**Radiated Frequency range above 1 GHz**

FCC 15B Radiated Emissions Limits				
Frequency range (GHz)	Class A (3m) (dB μ V/m)		Class B (3m) (dB μ V/m)	
	Peak	Average	Peak	Average
1 - 40	80	60	74	54

Note: 1. The lower limit shall apply at the transition frequency.

2. Detector function in the form: PK = Peak, QP = Quasi Peak, AV = Average

3. The test result calculated as following:

Measurement Value = Reading Level + Correct Factor

Correction Factor = Antenna factor + Cable loss (Antenna to preamplifier) - preamplifier Gain
+ Cable loss (preamplifier to receiver)

Margin Level = Measurement Value - Limit Value

Frequency Range (For unintentional radiators)

Highest frequency generated or used in the device or on which the device operates or tunes (MHz)	Upper frequency of measurement range (MHz)
Below 1.705	30
1.705-108	1000
108-500	2000
500-1000	5000
Above 1000	5th harmonic of the highest frequency or 40GHz, whichever is lower



4.2.2 Test Instrument

Test Site: W08-966-1					
Item	Equipment	Manufacturer	Model	Meter No.	Calibration Date
1	Horn Antenna	Schwarzbeck	BBHA 9120D	CT-9-031	Jul. 31, 2023
2	Horn Antenna	Schwarzbeck	BBHA 9170	CT-9-032	Aug. 29, 2023
3	TRILOG Broadband Antenna with 6 dB Attenuator	Schwarzbeck & MVE	VULB 9168 & MVE2251-06	CT-1-096-1	May 17, 2023
4	Spectrum Analyzer	Agilent	E4407B	CT-1-003(1)	Aug. 02, 2023
5	EXA Signal Analyzer	Keysight	N9010A	CT-1-093	Aug. 16, 2023
6	EMI Test Receiver	Keysight	N9038A	CT-9-007	Aug. 02, 2023
7	Preamplifier	EM	EM 330	CT-9-024	Aug. 03, 2023
8	Preamplifier	SGH & MCL	SGH118 & BW-S15W2+	CT-9-071	Aug. 03, 2023
9	Preamplifier	EMCI	EMC184045SE	CT-9-013	Aug. 18, 2023
10	Test Cable	EMCI	EMCCFD400-NM-NM-1000	CT-1-132	Aug. 03, 2023
11	Test Cable	PEWC	CFD400NL-LW-NM-NM-3000	CT-1-141	Aug. 03, 2023
12	Test Cable	EMCI	EMCCFD400-NM-NM-15000	CT-1-133	Aug. 03, 2023
13	Test Cable	EMCI	EMC104-SM-35M-600	CT-1-134	Aug. 03, 2023
14	Test Cable	MVE	280280.LL266.1400	CT-9-072	Aug. 03, 2023
15	Test Cable	EMCI	EMC102-KM-KM-600	CT-1-136	Aug. 17, 2023
16	Measurement Software	EZ-EMC	Ver :WD-03A1-1	CT-3-012	No calibration request

Note: 1. The calibration interval of the above test instruments is 12 months.



4.2.3 Test Procedure

- a. The table-top EUT was placed on the top of a turntable 0.8 meters above the ground at 3 m 966 chamber. The floor-standing EUT and all cables shall be insulated from the ground plane by up to 12 mm of insulating material if required. The table was rotated 360 degrees to determine the position of the high radiation emissions.
- b. The height of the test antenna shall vary between 1 m to 4 m. Both vertical and horizontal polarizations of the antenna were set to make the measurement.
- c. The EUT was set up as per the test configuration to simulate typical usage per the user's manual. All I/O cables were positioned to simulate typical usage. The actual test configuration, please refer to EUT test photos.
- d. The initial step in collecting radiated emission data is a Spectrum Mode scanning the measurement frequency range.

Below 1GHz:

Reading in which marked as QP or Peak means measurements by using Spectrum Mode with detector RBW=120kHz.

If the Spectrum Mode measured peak value compliance with and lower than Quasi Peak Limit, the EUT shall be deemed to meet QP Limits.

Above 1GHz:

Reading in which marked as Peak & AVG means measurements by using Spectrum Mode with setting in RBW=1MHz.

If the Spectrum Mode measured value compliance with the Peak Limits and lower than AVG Limits, the EUT shall be deemed to meet both Peak and AVG Limits.

- e. Emission frequency and amplitude were recorded, recording at least six highest emissions. The EUT and cable configuration of the above highest emission levels were recorded. The test data of the worst case was recorded.

4.2.4 Deviation from Test Standard

No deviation

4.2.5 Test Setup

< Radiated Emissions Frequency: 30 MHz to 1000 MHz >

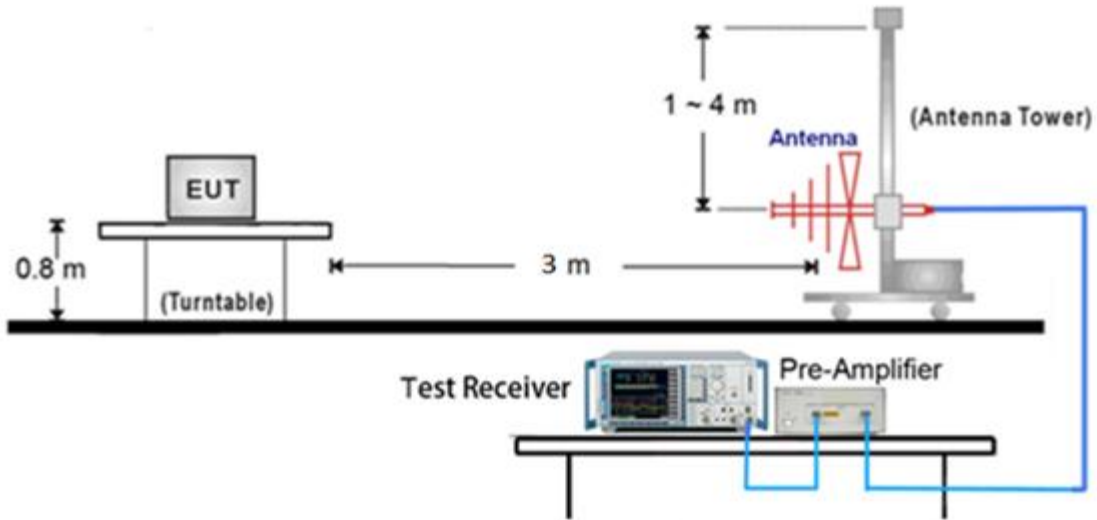

< Radiated Emissions Frequency: above 1GHz >

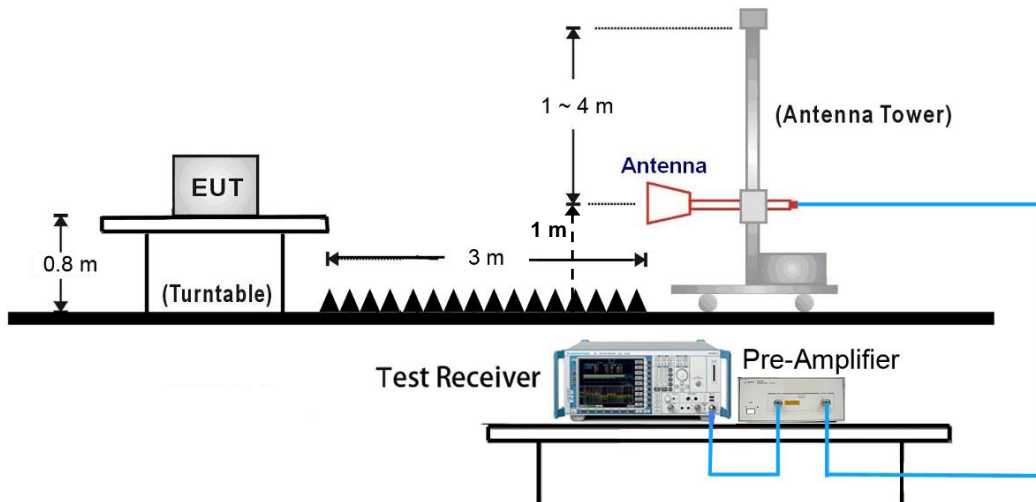

Note:

- (1) Please refer to the 4.2.7 for the actual test configuration.
- (2) The formula of measured value as: $\text{Test Result} = \text{Reading} + \text{Correction Factor}$
- (3) Detector function in the form: PK = Peak, QP = Quasi Peak, AV = Average
- (4) The test result calculated as following:
 $\text{Measurement Value} = \text{Reading Level} + \text{Correct Factor}$
 $\text{Correct Factor} = \text{Antenna Factor} + \text{Cable Loss} - \text{Amplifier Gain (if use)}$
 $\text{Margin Level} = \text{Measurement Value} - \text{Limit Value}$



4.2.6 Test Result

Test Voltage	120Vac, 60Hz	Frequency Range	30 – 1000 MHz
Environmental Conditions	25°C, 48% RH	6dB Bandwidth	120 kHz
Test Date	2023/09/11	Test Distance	3m
Tested by	Karwin Kao	Polarization	Vertical
Test Site	W08-966-1		

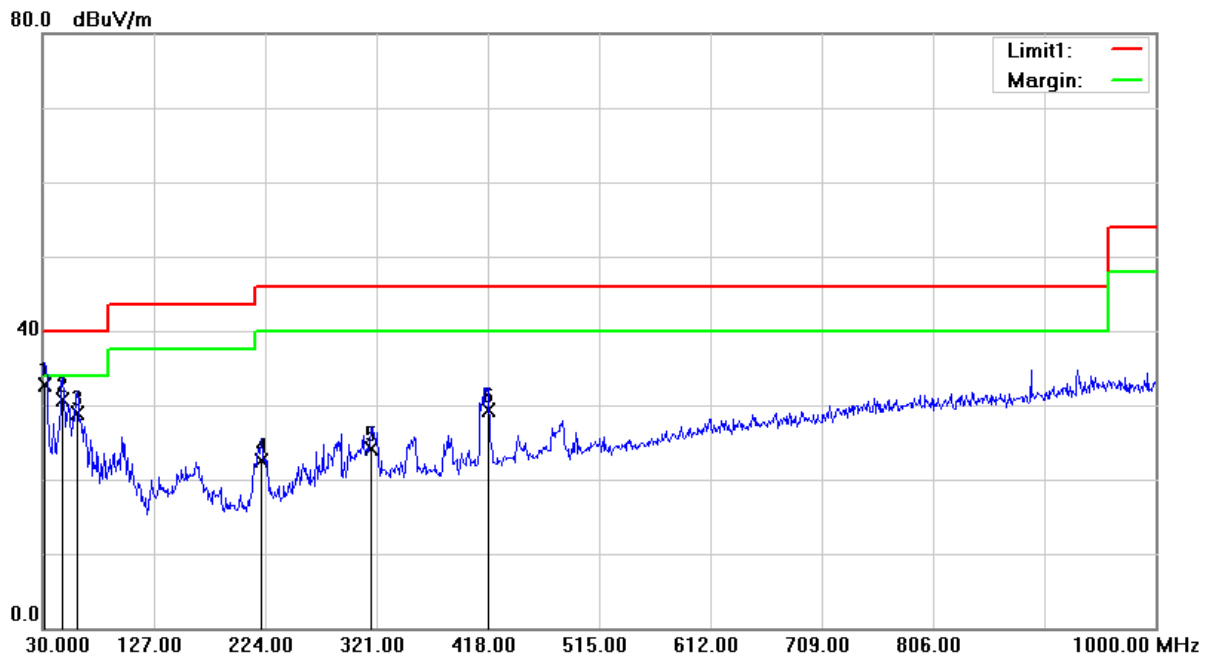

No.	Frequency (MHz)	Reading Level (dBμV)	Correct Factor (dB/m)	Measurement (dBμV/m)	Limit (dBμV/m)	Margin (dB)	Table Degree (degree)	Antenna Height (cm)	Detector
1	31.9400	44.26	-11.49	32.77	40.00	-7.23	316	100	QP
2	47.4600	40.21	-9.59	30.62	40.00	-9.38	360	159	QP
3	60.0700	39.19	-10.30	28.89	40.00	-11.11	293	100	QP
4	221.0900	35.00	-12.46	22.54	46.00	-23.46	150	100	QP
5	316.1500	32.12	-8.10	24.02	46.00	-21.98	174	100	QP
6	418.0000	34.62	-5.25	29.37	46.00	-16.63	144	100	QP

Remark: 1. QP = Quasi Peak
 2. Correction Factor = Antenna factor + Cable loss (Antenna to preamplifier) - preamplifier Gain + Cable loss (preamplifier to receiver)
 3. Measurement Value = Reading Level + Correct Factor
 4. Margin Level = Measurement Value - Limit Value



Test Voltage	120Vac, 60Hz	Frequency Range	30 – 1000 MHz
Environmental Conditions	25°C, 48% RH	6dB Bandwidth	120 kHz
Test Date	2023/09/11	Test Distance	3m
Tested by	Karwin Kao	Polarization	Horizontal
Test Site	W08-966-1		

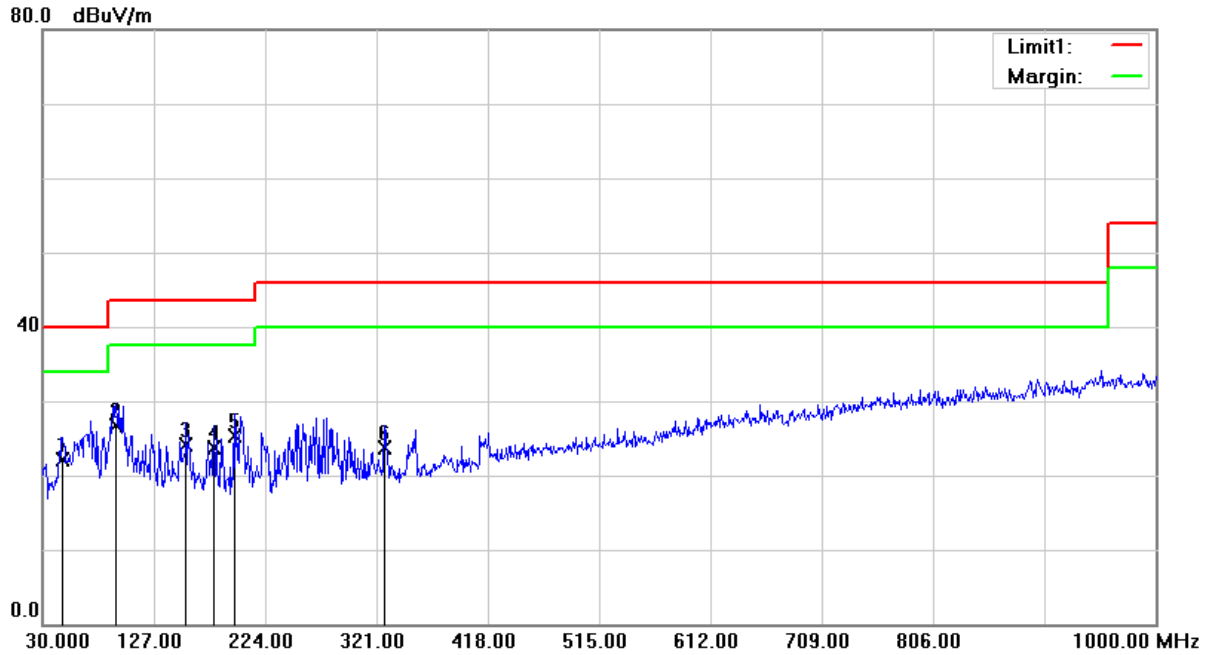

No.	Frequency (MHz)	Reading Level (dBµV)	Correct Factor (dB/m)	Measurement (dBµV/m)	Limit (dBµV/m)	Margin (dB)	Table Degree (degree)	Antenna Height (cm)	Detector
1	47.4600	31.64	-9.59	22.05	40.00	-17.95	107	200	QP
2	94.0200	42.01	-15.27	26.74	43.50	-16.76	134	200	QP
3	155.1300	33.52	-9.40	24.12	43.50	-19.38	269	200	QP
4	179.3800	34.56	-10.92	23.64	43.50	-19.86	269	200	QP
5	196.8400	37.89	-12.67	25.22	43.50	-18.28	360	146	QP
6	327.7900	31.37	-7.65	23.72	46.00	-22.28	49	100	QP

Remark:

1. QP = Quasi Peak
2. Correction Factor = Antenna factor + Cable loss (Antenna to preamplifier) - preamplifier Gain + Cable loss (preamplifier to receiver)
3. Measurement Value = Reading Level + Correct Factor
4. Margin Level = Measurement Value - Limit Value



Test Voltage	120Vac, 60Hz	Frequency Range	1 – 6GHz
Environmental Conditions	25°C, 48% RH	6dB Bandwidth	1MHz
Test Date	2023/09/11	Test Distance	3m
Tested by	Karwin Kao	Polarization	Vertical
Test Site	W08-966-1		

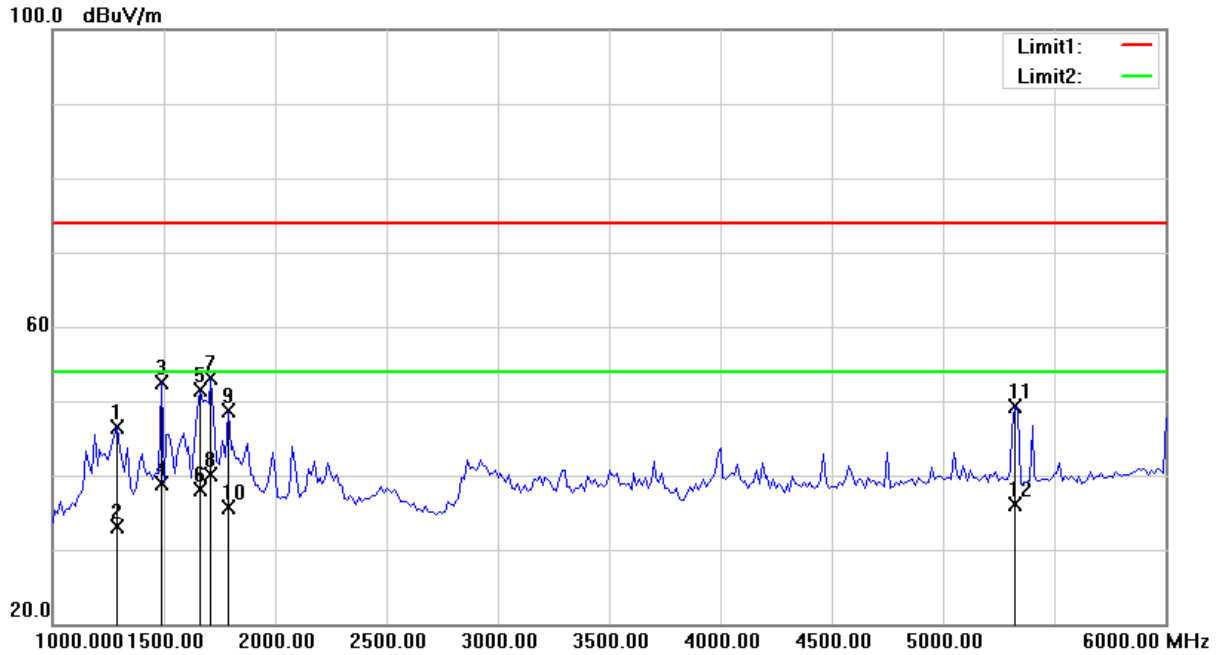

No.	Frequency (MHz)	Reading Level (dBμV)	Correct Factor (dB/m)	Measurement (dBμV/m)	Limit (dBμV/m)	Margin (dB)	Table Degree (degree)	Antenna Height (cm)	Detector
1	1287.500	63.90	-17.49	46.41	74.00	-27.59	221	100	peak
2	1287.500	50.52	-17.49	33.03	54.00	-20.97	221	100	AVG
3	1487.500	69.88	-17.36	52.52	74.00	-21.48	174	100	peak
4	1487.500	56.33	-17.36	38.97	54.00	-15.03	174	100	AVG
5	1662.500	68.90	-17.35	51.55	74.00	-22.45	199	100	peak
6	1662.500	55.36	-17.35	38.01	54.00	-15.99	199	100	AVG
7	1712.500	70.47	-17.39	53.08	74.00	-20.92	249	100	peak
8	1712.500	57.48	-17.39	40.09	54.00	-13.91	249	100	AVG
9	1787.500	65.83	-17.10	48.73	74.00	-25.27	201	200	peak
10	1787.500	52.80	-17.10	35.70	54.00	-18.30	201	200	AVG
11	5325.000	56.91	-7.54	49.37	74.00	-24.63	189	100	peak
12	5325.000	43.57	-7.54	36.03	54.00	-17.97	189	100	AVG

Remark: 1. peak = Peak, AVG = Average
 2. Correction Factor = Antenna factor + Cable loss (Antenna to preamplifier) - preamplifier Gain + Cable loss (preamplifier to receiver)
 3. Measurement Value = Reading Level + Correct Factor
 4. Margin Level = Measurement Value - Limit Value



Test Voltage	120Vac, 60Hz	Frequency Range	1 – 6GHz
Environmental Conditions	25°C, 48% RH	6dB Bandwidth	1MHz
Test Date	2023/09/11	Test Distance	3m
Tested by	Karwin Kao	Polarization	Horizontal
Test Site	W08-966-1		

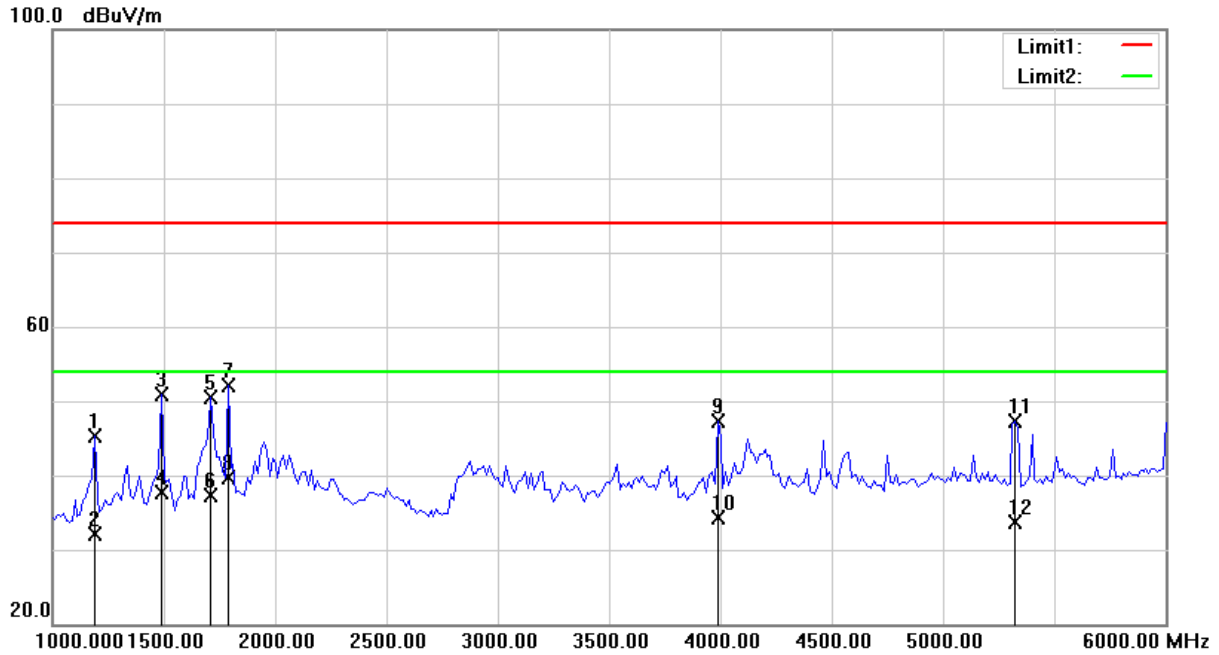

No.	Frequency (MHz)	Reading Level (dBμV)	Correct Factor (dB/m)	Measurement (dBμV/m)	Limit (dBμV/m)	Margin (dB)	Table Degree (degree)	Antenna Height (cm)	Detector
1	1187.500	63.51	-18.17	45.34	74.00	-28.66	125	100	peak
2	1187.500	50.18	-18.17	32.01	54.00	-21.99	125	100	AVG
3	1487.500	68.34	-17.36	50.98	74.00	-23.02	147	100	peak
4	1487.500	55.06	-17.36	37.70	54.00	-16.30	147	100	AVG
5	1712.500	67.91	-17.39	50.52	74.00	-23.48	235	100	peak
6	1712.500	54.68	-17.39	37.29	54.00	-16.71	235	100	AVG
7	1787.500	69.18	-17.10	52.08	74.00	-21.92	147	100	peak
8	1787.500	56.77	-17.10	39.67	54.00	-14.33	147	100	AVG
9	3987.500	57.63	-10.31	47.32	74.00	-26.68	329	100	peak
10	3987.500	44.71	-10.31	34.40	54.00	-19.60	329	100	AVG
11	5325.000	54.80	-7.54	47.26	74.00	-26.74	191	100	peak
12	5325.000	41.29	-7.54	33.75	54.00	-20.25	191	100	AVG

Remark: 1. peak = Peak, AVG = Average
 2. Correction Factor = Antenna factor + Cable loss (Antenna to preamplifier) - preamplifier Gain + Cable loss (preamplifier to receiver)
 3. Measurement Value = Reading Level + Correct Factor
 4. Margin Level = Measurement Value - Limit Value

4.2.7 Photographs of Test Configuration

Radiated Emission Test (30MHz~1GHz)



Radiated Emission Test (Above 1GHz)

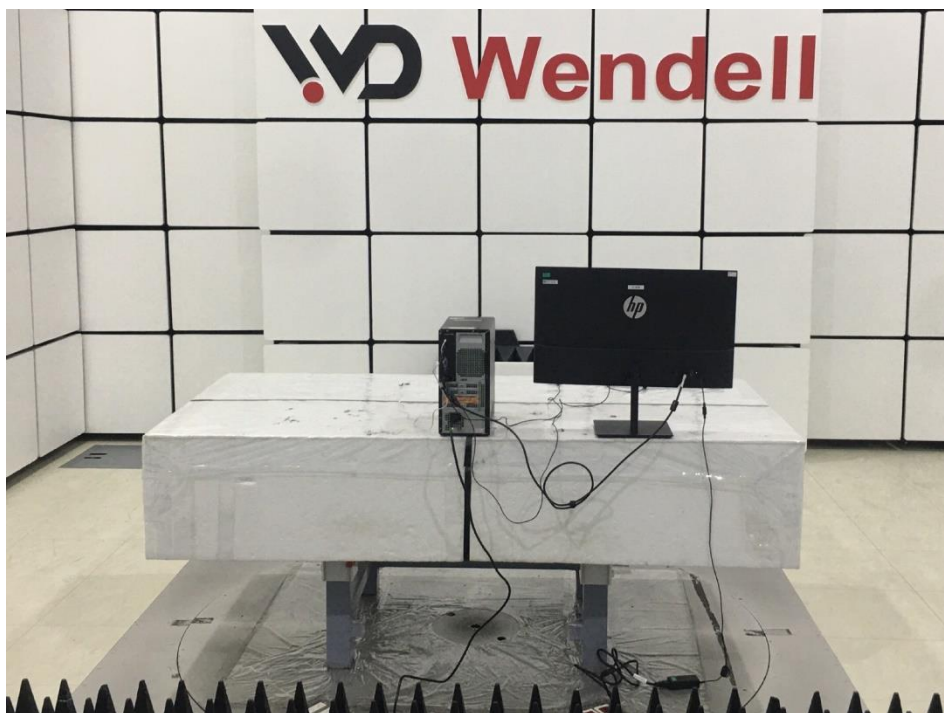
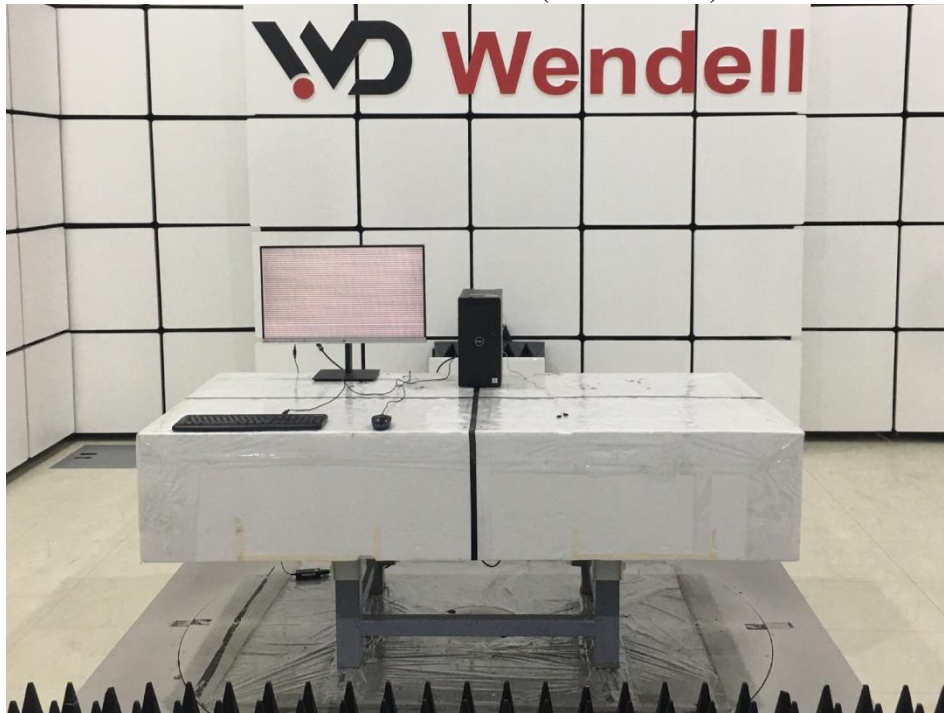

< End Page >