



FCC 47 CFR PART 15 SUBPART B

TEST REPORT

FOR

MO-297 SSD

Model : Sx170-297

Trade Name : Apacer

Issued to

Apacer Technology Inc.

**1F., No.32, Zhongcheng Rd., Tucheng Dist., New Taipei City 236, Taiwan
(R.O.C)**

Issued by

WH Technology Corp.



Open Site		No.120, Ln. 5, Hudong St., Xizhi Dist., New Taipei City 221, Taiwan (R.O.C.)
EMC Test Site	Xizhi Office and Lab	7F., No.262, Sec. 3, Datong Rd., Xizhi Dist., New Taipei City 221, Taiwan (R.O.C.)
Tel.: +886-2-7729-7707 Fax: +886-2- 8648-1311		

Note: This test refers exclusively to the test presented test model and sample. This report shall not be reproduced except in full, without the written approval of WH Technology Corp. . This document may be altered or revised by WH Technology Corp. . Personnel only, and shall be noted in the revision section of the document.



TABLE OF CONTENTS	2
1. GENERAL INFORMATION	3
1.1 DESCRIPTION OF THE TESTED SAMPLES	4
1.2 SUMMARY OF TEST RESULT	4
1.3 TEST METHODOLOGY	5
1.4 DESCRIPTION OF THE SUPPORT EQUIPMENTS	6
1.5 FEATURES OF EUT: PLEASE REFER TO USER MANUAL OR PRODUCT SPECIFICATION.	6
2. INSTRUMENT AND CALIBRATION	7
2.1 MEASURING INSTRUMENT CALIBRATION	7
2.2 TEST AND MEASUREMENT EQUIPMENT	7
2.3 TEST PERFORMED	8
2.4 APPENDIX	8
3. CONDUCTED EMISSION MEASUREMENT	12
3.1 TEST SET-UP (PLEASE REFER TO APPENDIX 1)	12
3.2 LIMIT	12
3.3 TEST PROCEDURE	12
3.4 TEST SPECIFICATION	13
3.5 RESULT: PASSED	13
3.6 TEST DATA:	13
4. RADIATED EMISSION MEASUREMENT	14
4.1 TEST SETUP (PLEASE REFER TO APPENDIX 1)	14
4.2 LIMIT	15
4.3 TEST PROCEDURE	15
4.4 TEST SPECIFICATION	15
4.5 RESULT: PASSED	16
4.6 TEST DATA:	16
5. MEASUREMENT UNCERTAINTY	17
APPENDIX 1	
PHOTOS OF TEST CONFIGURATION	
APPENDIX 2	
TEST DATA	
APPENDIX 3	
PHOTOS OF EUT	



1. GENERAL INFORMATION

Applicant : Apacer Technology Inc.
Address : 1F., No.32, Zhongcheng Rd., Tucheng Dist., New Taipei City
236, Taiwan (R.O.C)
Manufacturer : Apacer Technology Inc.
Address : 1F., No.32, Zhongcheng Rd., Tucheng Dist., New Taipei City
236, Taiwan (R.O.C)
EUT : MO-297 SSD
Model Name : Sx170-297
Model Differences : N/A
Receipt Date : JUL. 03, 2018
Final Test Date : JUL. 18, 2018

Is herewith confirmed to comply with the requirements set out in the FCC Rules and Regulations described below and the measurement procedures were according to ANSI C63.4-2014. The said equipment in the configuration described in this report shows the maximum emission levels emanating from equipment are within the compliance requirements.

FCC part 15 subpart B

Class B

Tested By:

Reviewed by:

JUL. 18, 2018
(Date)

Bell Wei/ Engineer

JUL. 18, 2018
(Date)

Mike Lee / Manager

FCC Designation Number: TW1083



1.1 DESCRIPTION OF THE TESTED SAMPLES

EUT

- EUT Type : Engineer Type
- Condition when received : Good Damage :
- EUT Name : MO-297 SSD
- Model Number : Sx170-297
- Receipt Date : 07/03/2018
- EUT Power Rating : AC Power
 DC Power
 DCV from PC
 DCV from Adaptor
- EUT highest operating frequency : Below 1GHz
- EUT peripheral EQUIPMENT : N/A
- I/O Port of EUT : N/A

1.2 SUMMARY OF TEST RESULT

Emission			
Test Standard	Test Item	Test Result	Worse Emission
FCC Part 15B Class B	Conducted Emission	Pass	Neutral 6.84 MHz, 21.55 dB Margin
FCC Part 15B Class B	Radiated Emission	Pass	Below 1GHz Vertical 167.74 MHz, 5.17 dB Margin



1.3 TEST METHODOLOGY

1.3.1 EUT SYSTEM OPERATION

1. EUT is fully system and power on.
2. Exercise software is EMCTEST and run ITU-R BT 1729 color bar.
3. Perform the EMC testing procedures, and measure the maximum emission noise.

1.3.2 DESCRIPITON OF TEST MODES

To investigate the maximum EMI emission characteristics generates from EUT, the test system was pre-scanning tested base on the consideration of following EUT operation mode or test configuration mode which possible have effect on EMI emission level. Each of these EUT operation mode(s) or test configuration mode(s) mentioned above was evaluated respectively.

Pretest Test Mode	Description
Mode 1	Read/Write

Conducted emission test	
Final Test Mode	Description
Mode 1	Read/Write

Radiated emission test	
Final Test Mode	Description
Mode 1	Read/Write



1.4 DESCRIPTION OF THE SUPPORT EQUIPMENTS

Setup Diagram

See test photographs attached in appendix I for the actual connections between EUT and support equipment.

Support Equipment

Peripherals Devices:

OUTSIDE SUPPORT EQUIPMENT							
No.	Equipment	Model	Serial No.	FCC ID/ BSMI ID	Trade name	Data Cable	Power Cord
1.	PC	D13M	FZHBW02	R33002	DELL	N/A	Unshielded 1.8m
2.	Monitor	UZ2315Hf	CN-0NJ1C5- 72872-473-A F2SREVA02	R43002	DELL	Shielded 1.8m	Unshielded 1.8m
3.	Printer	D4360	N/A	R33001	HP	Shielded 1.8m / USB	Unshielded 1.8m
4.	USB 3.0	TC100-001	NA	D43606	TCELL	Shielded 1m / USB	N/A
5.	Mouse	MS116p	CN-04DWD N-73826-5C M-0120	R41108	DELL	Shielded 1.8m / USB	N/A
6	Keyboard	KB216p	CN-005TW2-7 1581-5AF-01I3 -A01	D41108	DELL	Shielded 1.8m / USB	N/A

Note: All the above equipment /cable were placed in worse case position to maximize emission signals during emission test.

Grounding: Grounding was in accordance with the manufacturer's requirement and conditions for the intended use.

1.5 FEATURES OF EUT: PLEASE REFER TO USER MANUAL OR PRODUCT SPECIFICATION.



2. INSTRUMENT AND CALIBRATION

2.1 MEASURING INSTRUMENT CALIBRATION

The measuring equipment utilized to perform the tests documented in the report has been calibrated once a year or in accordance with the manufacturer's recommendations, and is traceable to recognized national standards.

2.2 TEST AND MEASUREMENT EQUIPMENT

The following list contains measurement equipment used for testing. The equipment conforms to the requirement of CISPR 16-1, ANSI C63.2 and. Other required standards.

Calibration of all test and measurement, including any accessories that may effect such calibration, is checked frequently to ensure the accuracy. Adjustments are made and correction factors are applied in accordance with the instructions contained in the respective.

TABLE LIST OF TEST AND MEASUREMENT EQUIPMENT

Test Site	Instrument	Manufacturer	Model No.	S/N	Next Cal. Date
Conduction	Spectrum (9K--3GHz)	R&S	FSP3	833387/010	2018/12/07
	EMI Receiver	R&S	ESHS10	830223/008	2019/06/10
	LISN	Rolf Heine Hochfrequenztechnik	NNB-2/16z	98062	2019/06/13
	ISN	Schwarzbeck	8-Wire ISN CAT5	CAT5-8158-0094	2018/10/19
	RF Cable	N/A	N/A	EMI-3	2018/10/17
Radiation	Bilog antenna(30M-1GHz)	ETC	MCTD2786B	BLB16M04004/JB-5-004	2019/05/30
	Double Ridged Guide Horn antenna(1G-18GHz)	ETC	MCTD 1209	DRH15N02009	2018/11/28
	Horn antenna (18G-26GHz)	com-power	AH-826	81000	2018/08/16
	LOOP Antenna (Below 30MHz)	com-power	AL-130	17117	2018/11/12
	Pre amplifier (30M-1GHz)	EMC INSTRUMENT	EMC9135	980334	2019/05/08



	Microwave Preamplifier (1G-18GHz)	EMC INSTRUMENT	EMC051845	980108&A T -18001	2018/11/27
	Pre amplifier (18G~26GHz)	MITEQ	JS4-18002600-30-5A	808329	2018/08/09
	EMI Test Receiver	R&S	ESVS30 (20M-1000MHz)	826006/002	2018/11/07
	RF Cable (9K-1GHz)	EMCI	N male on end of both sides (EMI4)	30m	2018/11/09
	RF CABLE (1~26GHz)	SUCOFLEX	104PEA	NA	2019/05/07
	RF CABLE (1~18GHz)	HARBOUR INDUSTRIES	LL142MI(7M)	NA	2018/08/09
	RF CABLE (18~26GHz)	AGILENT	EMC102-KM-KM-600	160102	2019/04/18
	Spectrum (9K--7GHz)	R&S	FSP7	830180/006	2019/04/18
	Spectrum (9K--40GHz)	AGILENT	8564EC	4046A0032	2019/02/28
Software	e3	AUDIX	N/A	N/A	N/A
SG	SINGAL GENERATOR (100k-1GHz)	HP	8648A	3619U0042 6	N/A

※ Calibration interval of instruments listed above is one year

2.3 TEST PERFORMED

Conducted emissions were investigated over the frequency range from 0.15 MHz to 30 MHz using a receiver which bandwidth is set at 9 KHz.

Radiated emissions were investigated over the frequency range from 30 MHz to 1000 MHz using a receiver which bandwidth is set at 120 KHz. Radiated measurement was performed at distance that from an antenna to EUT is 10 meters.

2.4 APPENDIX

Appendix A: Measurement Procedure for Main Power Port Conducted Emissions

The measurements are performed in a WH lab test room; The EUT was placed on non-conductive 1.0m x 1.5m table, which is 0.8 meters above an earth-grounded.

Power to the EUT was provided through the LISN which has the Impedance (50 ohm/50 uH) vs. Frequency Characteristic in accordance with the standard. Powers to the LISNs were filtered to eliminate ambient signal interference and these filters were bonded to the ground plane. Peripheral equipment required to provide a functional system (support equipment) for EUT testing was powered from the second



LISN through a ganged, metal power outlet box which is bonded to the ground plane at the LISN.

If the EUT is supplied with a flexible power cord, the power cord length in excess of the distance separating the EUT from the LISN shall be folded back and forth at the center of the lead so as to form a bundle not exceeding 40 cm in length. If the EUT is provided with a permanently coiled power cord, bundling of the cord is not required. If the EUT is supplied without a power cord, the EUT shall be connected to the LISN by a power cord of the type specified by the manufacturer which shall not be longer than 1 meter. The excess power cord shall be bundled as described above. If a non-flexible power cord is provided with the EUT, it shall be cut to the length necessary to attach the EUT to the LISN and shall not be bundled.

The interconnecting cables were arranged and moved to get the maximum measurement. Both the line of power cord, hot and neutral, was measured.

The highest emissions were analyzed in details by operating the spectrum analyzer in fixed tuned mode to determine the nature of the emissions and to provide information which could be useful in reducing their amplitude.

Appendix B: Test Procedure for Radiated Emissions

Preliminary Measurements in Semi Anechoic Chamber

The radiated emissions are initially measured in the anechoic chamber at a measurement distance of 3 meters. Desktop EUT are placed on a wooden stand 0.8 meter in height. The measurement antenna is 3 meters from the EUT. The test setup in anechoic chamber is the same as open site. The turntable rotated 360°. The antenna height is 1m. The primary objective of the radiated measurements in the anechoic chamber is to identify the frequency spectrum in the absence of the electromagnetic environment existing on the open test site. The frequencies can then be pre-selected on the open test site to obtain the corresponding amplitude. The initial scan is made with the spectrum analyzer in automatic sweep mode. The spectrum peaks are then measured manually to determine the exact frequencies.

Measurements on the Open Site

The radiated emissions test will then be repeated on the open site or chamber to measure the amplitudes accurately and without the multiple reflections existing in the shielded room. The EUT and support equipments are set up on the turntable. Desktop EUT are set up on a wooden stand 0.8 meter above the ground.

For the initial measurements, the receiving antenna is varied from 1-4 meter height and is changed in the vertical plane from vertical to horizontal polarization at each frequency. Both reading are recorded with the quasi-peak detector with 120



KHz bandwidth. For frequency between 30 MHz and 1000 MHz, the reading is recorded with peak detector or quasi-peak detector.

At the highest amplitudes observed, the EUT is rotated in the horizontal plane while changing the antenna polarization in the vertical plane to maximize the reading. The interconnecting cables were arranged and moved to get the maximum measurement. Once the maximum reading is obtained, the antenna elevation and polarization will be varied between specified limits to maximize the readings.



Appendix C: Warning Labels

Label Requirements

A Class B digital device subject to certification by the FCC shall carry a warning label which includes the following statement:

***** WARNING *****

This device complies with Part 15 of the FCC Rules. Operation is subject to the following two conditions: (1) this device may not cause harmful interference, and (2) this device must accept any interference received, including interference that may cause undesired operation.

Appendix D: Warning Statement

Statement Requirements

The operator's manual for a Class A digital device shall contain the following statements or their equivalent:

***** WARNING *****

This equipment has been tested and found to comply with the limits for a Class A digital device, pursuant to part 15 of the FCC Rules. These limits are designed to provide reasonable protection against harmful interference when the equipment is operated in a commercial environment. This equipment generates, uses, and can radiate radio frequency energy and, if not installed and used in accordance with the instruction manual, may cause harmful interference to radio communications. Operation of this equipment in a residential area is likely to cause harmful interference in which case the user will be required to correct the interference at his own expense.

Notice: The changes or modifications not expressly approved by the party responsible for compliance could void the user's authority to operate the equivalent.

* * * * *

If the EUT was tested with special shielded cables the operator's manual for such product shall also contain the following statements or their equivalent:

Shielded interface cables and/or AC power cord, if any, must be used in order to comply with the emission limits.



3. CONDUCTED EMISSION MEASUREMENT

3.1 TEST SET-UP (PLEASE REFER TO APPENDIX 1)

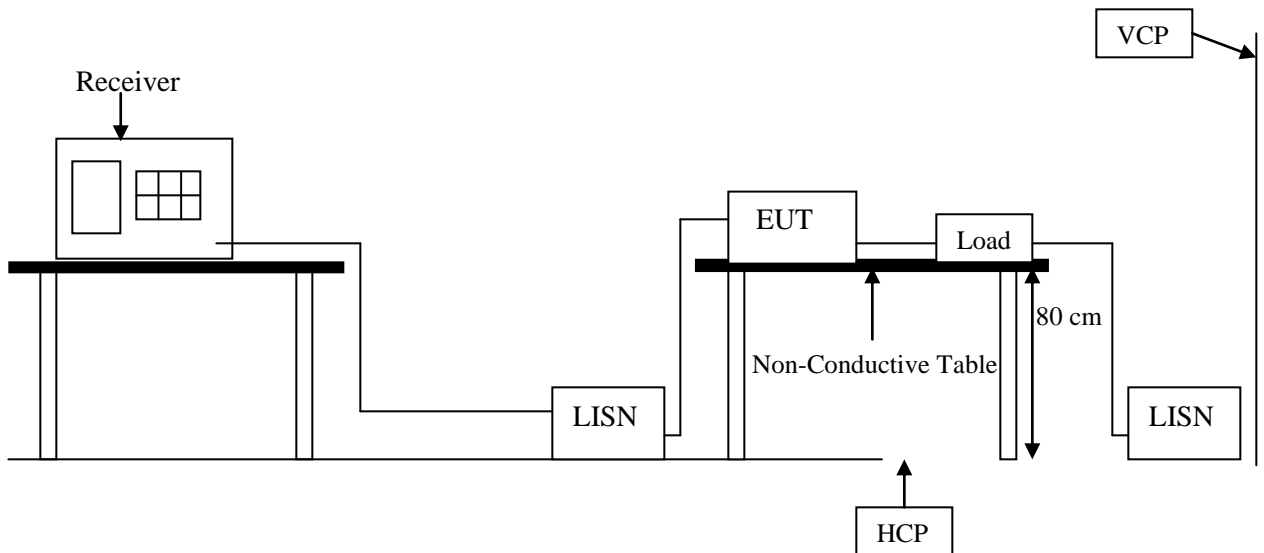

3.2 LIMIT

Frequency range (MHz)	CLASS A		CLASS B	
	QP dB(uV)	Average dB(uV)	QP dB(uV)	Average dB(uV)
0.15-0.5	79 dBuV	66 dBuV	66 - 56 dBuV	56 - 46 dBuV
0.5-5.0	73 dBuV	60 dBuV	56 dBuV	46 dBuV
5.0-30.0	73 dBuV	60 dBuV	60 dBuV	50 dBuV

Remark: In the above table, the tighter limit applies at the band edges.

3.3 TEST PROCEDURE

Please refer 2.4 Appendix

Appendix A: Measurement Procedure for Main Power Port Conducted Emissions

Note:

1. Reading in which marked as Peak, QP or AVG means measurements by using are Quasi-Peak or Average Mode with Detector BW=9 kHz (6 dB Bandwidth).
2. All readings are Peak Mode value unless otherwise stated QP or AVG in column of Note. If the Peak or QP Mode Measured value compliance with the QP Limits and lower than AVG Limits, the EUT shall be deemed to meet both QP & AVG Limits and then only Peak or QP Mode was measured, but AVG Mode didn't perform.



3.4 TEST SPECIFICATION

ANSI C63.4 – 2014 Section 5.2, 7.1, 7.2 & FCC PART 15 SUBPART B CLASS B

3.5 RESULT: PASSED

Temperature:	26 °C
Humidity:	40 % RH

3.6 TEST DATA:

Please refer to appendix 2.



4. RADIATED EMISSION MEASUREMENT

4.1 TEST SETUP (PLEASE REFER TO APPENDIX 1)

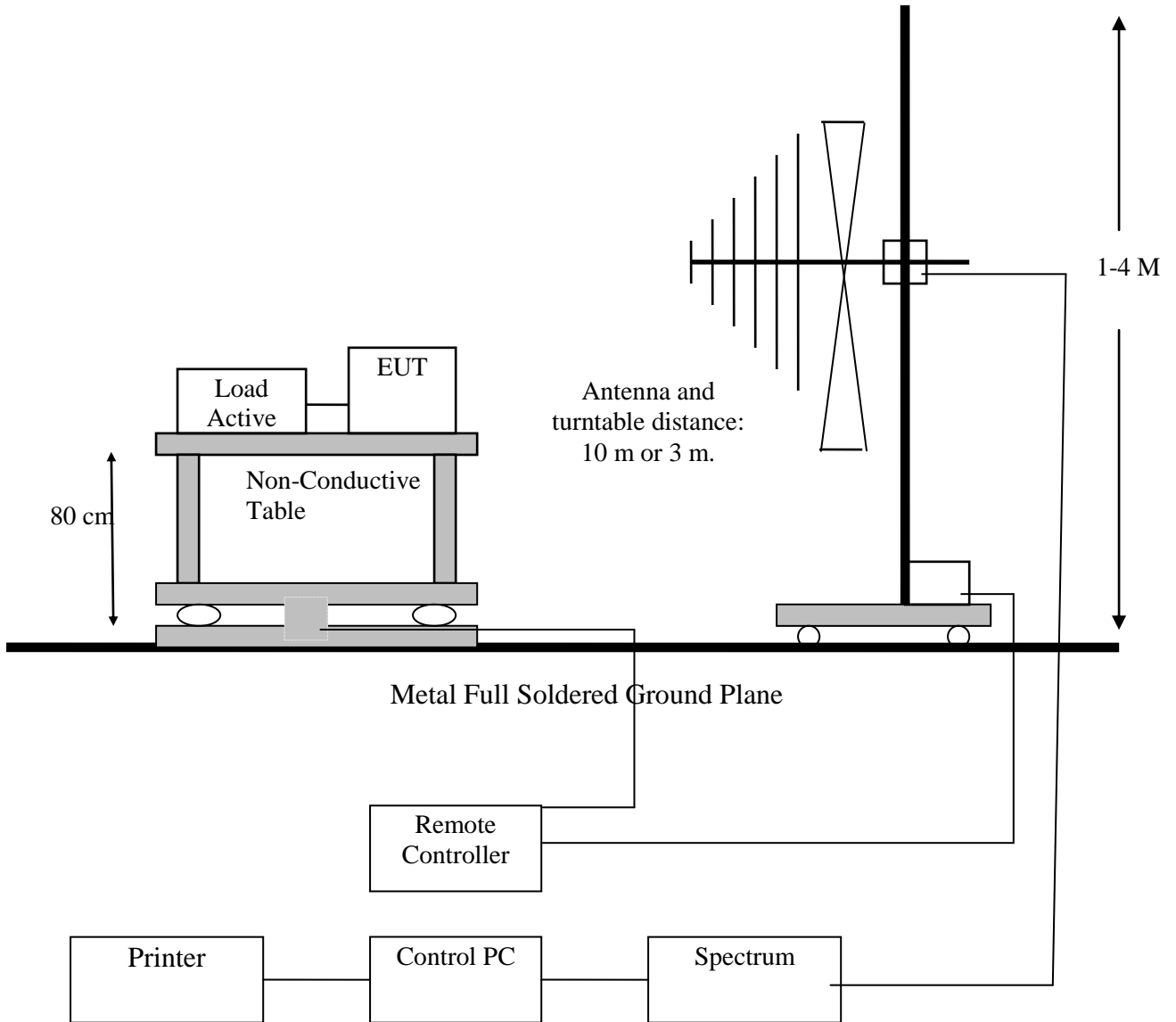



4.2 LIMIT

Frequency	Class A		Class B	
MHz	Distance (Meter)	Limit dB μ V/m	Distance (Meter)	Limit dB μ V/m
30 ~ 230	10	40	10	30
230 ~ 1000	10	47	10	37

Frequency range GHz	Average limit dB(μ V/m)	Peak limit dB(μ V/m)
Above 1000	54	74

Remark: In the above table, the tighter limit applies at the band edges

4.3 TEST PROCEDURE

Please refer 2.4 Appendix

Appendix B: Test Procedure for Radiated Emissions

Note:

Below 1GHz

1. Reading in which marked as QP or Peak means measurements by using are Quasi-Peak Mode with Detector BW=120 kHz..

2. All readings are Peak unless otherwise stated QP in column of Note. Peak denotes that the Peak reading compliance with the QP Limits and then QP Mode measurement didn't perform.

Above 1 GHz

1. Reading in which marked as Peak means measurements by using are Peak Mode with instrument setting in RBW=1 MHz, VBW= 1MHz.

Reading in which marked as AV means measurements by using are Average Mode with instruments setting in RBW=1 MHz, VBW= 1MHz.

2. All readings are Peak Mode value unless otherwise stated AVG in column of Note. If the Peak be deemed to meet both Peak & AVG Limits and then only Peak Mode was measured, but AVG Mode didn't perform.

4.4 TEST SPECIFICATION

ANSI C63.4 – 2014 Section 5.4, 5.5, 8 & FCC PART 15 SUBPART B CLASS B



4.5 RESULT: PASSED

Temperature:	22 °C
Humidity:	66 % RH

4.6 TEST DATA:

Please refer to appendix 2.



5. MEASUREMENT UNCERTAINTY

Measurement Item	Measurement Frequency	Polarization	Uncertainty
Conducted Emission	9 kHz ~ 30 MHz	LINE/NEUTRAL	3.54 dB
Radiated Emission	Below 1GHz	Horizontal	2.81 dB
		Vertical	4.01 dB
	Above 1GHz	Horizontal	4.64 dB
		Vertical	5.16 dB



SAMPLE OF FCC VERIFICATION LABEL 1

This device complies with part 15 of the FCC Rules. Operation is subject to the following two conditions: (1) This device may not cause harmful interference. And (2) this device must accept any interference received, including interference that may cause undesired operation.

SAMPLE OF FCC DoC LABEL 2

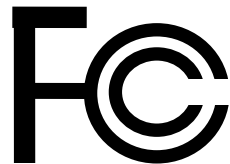

Trade Name
Model Number



PHOTOS OF TEST CONFIGURATION

Photograph – Conducted Emission Test Setup

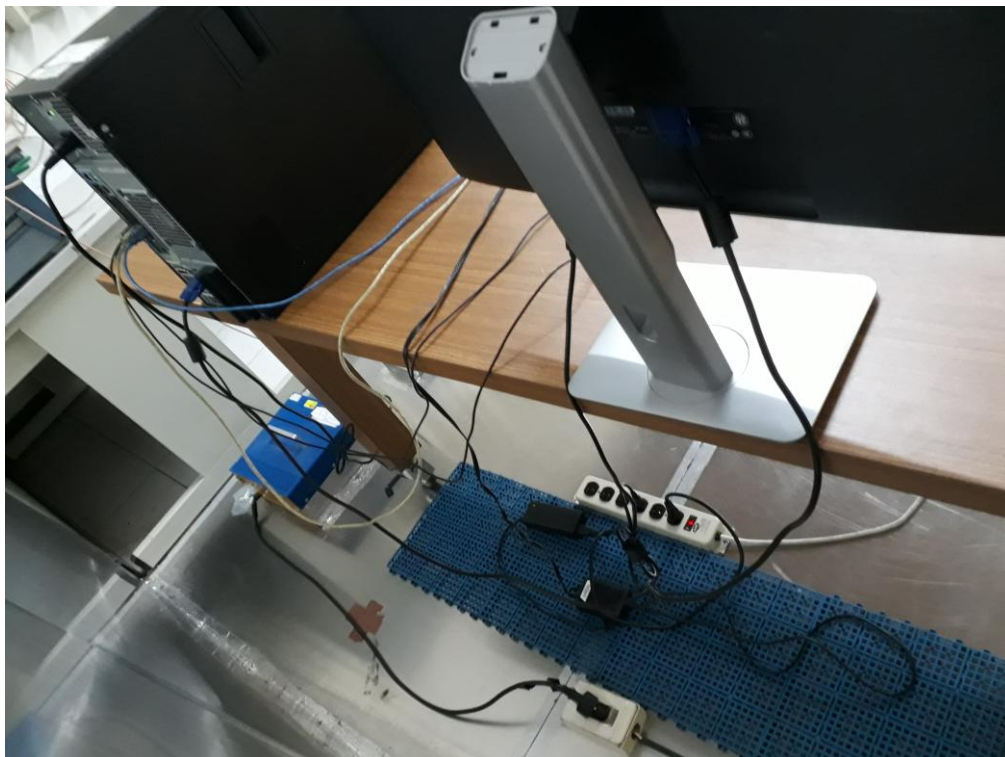

Photograph – Radiated Emission Test Setup



APPENDIX 2



TEST DATA

Test Data – Conducted Emission

Phase: L

Date: 2018-07-13

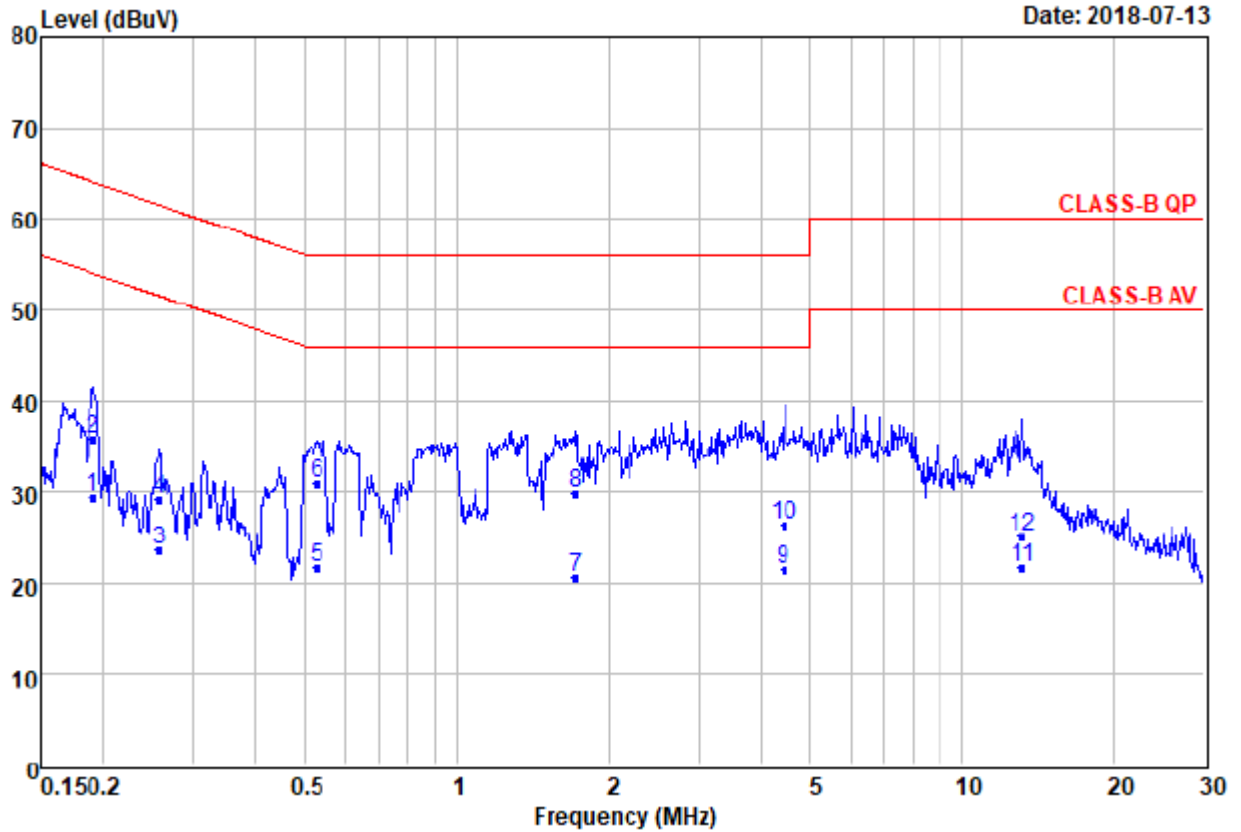

-----:-----

Remarks : Factor=Insrtion loss+Cable loss

	Read	Over	Limit			
Freq	Level	Level	Factor	Limit	Line	Remark
MHz	dBuV	dBuV	dB	dB	dBuV	
1	0.19	19.20	29.31	10.11	-24.71	54.02 Average
2	0.19	25.80	35.91	10.11	-28.11	64.02 QP
3	0.26	13.51	23.62	10.11	-27.94	51.56 Average
4	0.26	19.01	29.12	10.11	-32.44	61.56 QP
5 @	0.53	11.60	21.74	10.14	-24.26	46.00 Average
6	0.53	20.80	30.94	10.14	-25.06	56.00 QP
7	1.72	10.40	20.60	10.20	-25.40	46.00 Average
8	1.72	19.70	29.90	10.20	-26.10	56.00 QP
9	4.43	11.21	21.50	10.29	-24.50	46.00 Average
10	4.43	16.11	26.40	10.29	-29.60	56.00 QP
11	13.13	11.20	21.72	10.52	-28.28	50.00 Average
12	13.13	14.60	25.12	10.52	-34.88	60.00 QP

Phase: N

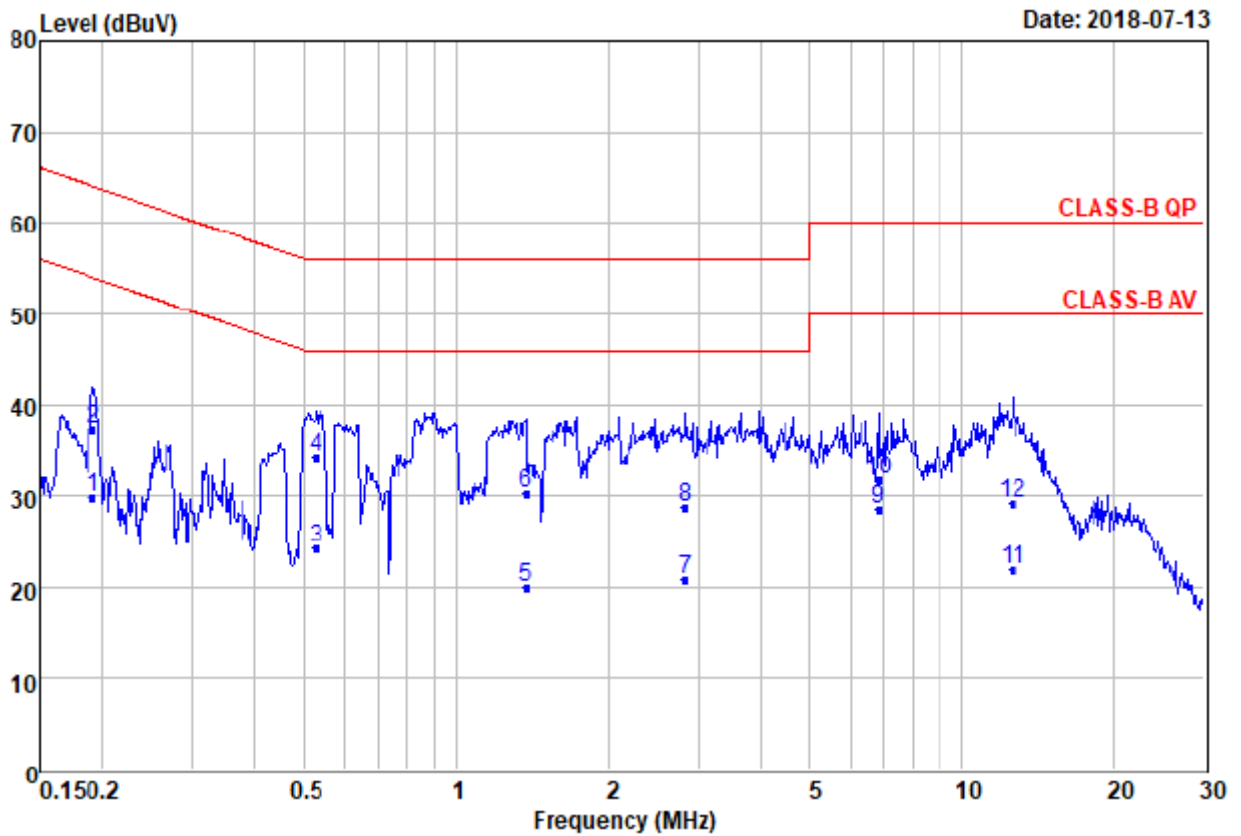

Remarks

: Factor=Insrtion loss+Cable loss

	Read	Over	Limit	Limit	Line	Remark
Freq	Level	Level	Factor	Limit	Line	
MHz	dBuV	dBuV	dB	dB	dBuV	
1	0.19	19.80	29.90	10.10	-24.08	53.98 Average
2	0.19	27.30	37.40	10.10	-26.58	63.98 QP
3	0.53	14.20	24.33	10.13	-21.67	46.00 Average
4	0.53	24.10	34.23	10.13	-21.77	56.00 QP
5	1.37	9.80	19.97	10.17	-26.03	46.00 Average
6	1.37	20.10	30.27	10.17	-25.73	56.00 QP
7	2.82	10.60	20.83	10.23	-25.17	46.00 Average
8	2.82	18.60	28.83	10.23	-27.17	56.00 QP
9 @	6.84	18.10	28.45	10.35	-21.55	50.00 Average
10	6.84	21.40	31.75	10.35	-28.25	60.00 QP
11	12.58	11.50	21.98	10.48	-28.02	50.00 Average
12	12.58	18.70	29.18	10.48	-30.82	60.00 QP

Test Data – Radiated Emission-Below 1GHz



Polarization: Horizontal

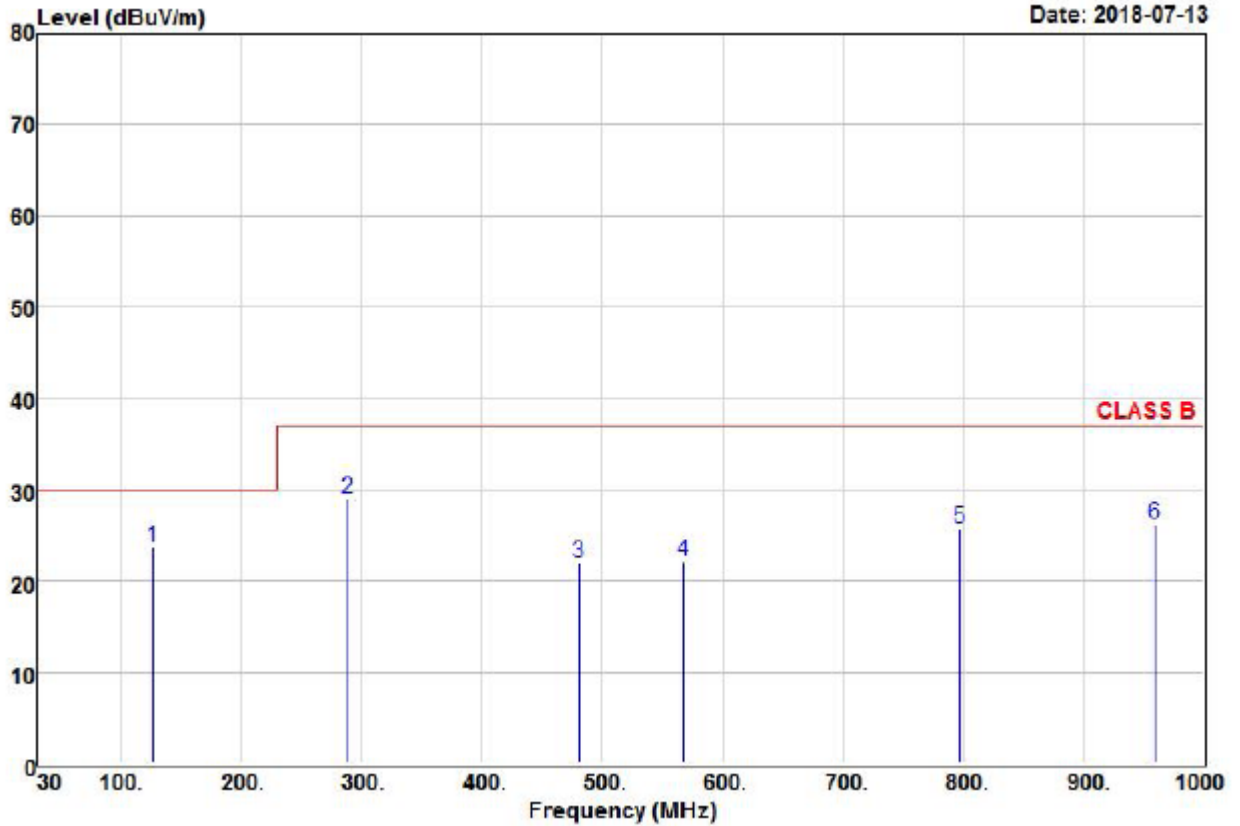

Remarks: : 1.Result=Read Value+Factor
: 2.Factor=Antenna Factor+Cable loss-
: Amplifier Factor

	Freq	Read Level	Factor	Level	Over Limit	Limit Line	Remark
	MHz	dBuV	dB/m	dBuV/m	dB	dBuV/m	
1 @	125.96	38.75	-15.05	23.70	-6.30	30.00	QP
2	288.02	43.23	-14.25	28.98	-8.02	37.00	QP
3	480.08	31.96	-10.05	21.91	-15.09	37.00	QP
4	567.38	31.48	-9.37	22.11	-14.89	37.00	QP
5	797.27	31.54	-5.86	25.68	-11.32	37.00	QP
6	960.23	28.28	-1.98	26.30	-10.70	37.00	QP

Polarization: Vertical

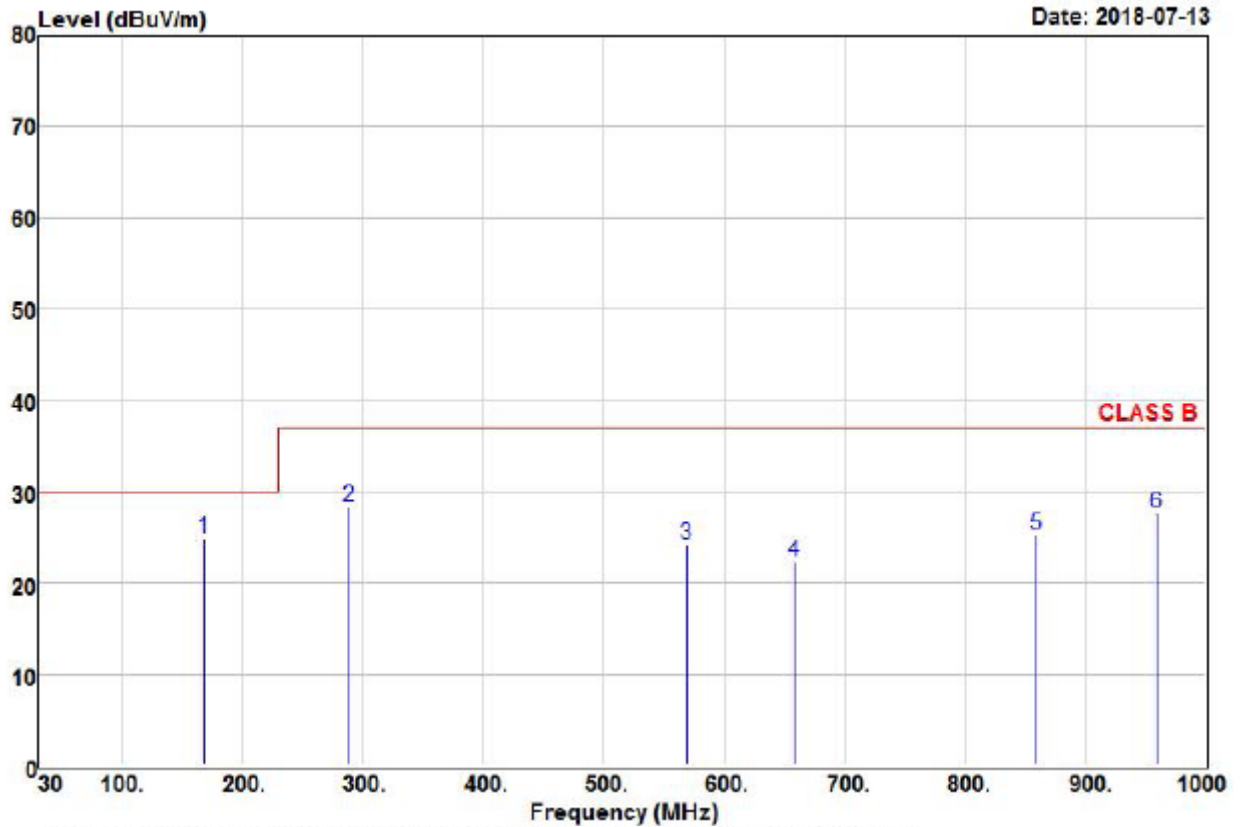

Remarks: : 1.Result=Read Value+Factor
: 2.Factor=Antenna Factor+Cable loss-
: Amplifier Factor

	Read	Over	Limit			
Freq	Level	Factor	Level	Limit	Line	Remark
MHz	dBuV	dB/m	dBuV/m	dB	dBuV/m	
1 @	167.74	43.21	-18.38	24.83	-5.17	30.00 QP
2	288.02	42.50	-14.25	28.25	-8.75	37.00 QP
3	568.35	33.48	-9.37	24.11	-12.89	37.00 QP
4	658.56	30.12	-7.79	22.33	-14.67	37.00 QP
5	860.32	29.95	-4.82	25.13	-11.87	37.00 QP
6	960.23	29.50	-1.98	27.52	-9.48	37.00 QP

APPENDIX 3



PHOTOS OF EUT

