



FCC 47 CFR PART 15 SUBPART B

TEST REPORT

FOR

SATA3 SSD

Model :SM220-297 32GB 8192Mx8*4

Trade Name: Apacer

Issued to

Apacer Technology Inc.

1F, No 32, Zhongcheng Rd, Tucheng Dist, New Taipei City 236, Taiwan(R.O.C)

Issued by

WH Technology Corp.

Open Site		No.120, Ln. 5, Hudong St., Xizhi Dist., New Taipei City 221, Taiwan (R.O.C.)
EMC Test Site	Xizhi Office and Lab	7F., No.262, Sec. 3, Datong Rd., Xizhi Dist., New Taipei City 221, Taiwan (R.O.C.)
Tel.: +886-2-7729-7707 Fax: +886-2- 8648-1311		

Note: This test refers exclusively to the test presented test model and sample. This report shall not be reproduced except in full, without the written approval of WH Technology Corp. . This document may be altered or revised by WH Technology Corp. . Personnel only, and shall be noted in the revision section of the document.



TABLE OF CONTENTS -----	2
1. GENERAL INFORMATION -----	3
1.1 DESCRIPTION OF THE TESTED SAMPLES -----	4
1.2 SUMMARY OF TEST RESULT -----	4
1.3 TEST METHODOLOGY -----	5
1.4 DESCRIPTION OF THE SUPPORT EQUIPMENTS -----	6
1.5 FEATURES OF EUT: PLEASE REFER TO USER MANUAL OR PRODUCT SPECIFICATION.-----	6
2. INSTRUMENT AND CALIBRATION -----	7
2.1 MEASURING INSTRUMENT CALIBRATION-----	7
2.2 TEST AND MEASUREMENT EQUIPMENT -----	7
2.3 TEST PERFORMED -----	8
2.4 APPENDIX-----	9
3. CONDUCTED EMISSION MEASUREMENT -----	12
3.1 TEST SET-UP (PLEASE REFER TO APPENDIX 1)-----	12
3.2 LIMIT-----	12
3.3 TEST PROCEDURE -----	12
3.4 TEST SPECIFICATION -----	13
3.5 RESULT: PASSED-----	13
3.6 TEST DATA: -----	13
4. RADIATED EMISSION MEASUREMENT -----	14
4.1 TEST SETUP (PLEASE REFER TO APPENDIX 1)-----	14
4.2 LIMIT-----	15
4.3 TEST PROCEDURE -----	15
4.4 TEST SPECIFICATION -----	15
4.5 RESULT: PASSED-----	16
4.6 TEST DATA: -----	16
5. MEASUREMENT UNCERTAINTY -----	17
APPENDIX 1	
PHOTOS OF TEST CONFIGURATION	
APPENDIX 2	
TEST DATA	
PHOTOS OF EUT	



1. GENERAL INFORMATION

Applicant : Apacer Technology Inc.
Address : 1F, No 32, Zhongcheng Rd, Tucheng Dist, New Taipei City 236, Taiwan(R.O.C)
Manufacturer : Apacer Technology Inc.
Address : 1F, No 32, Zhongcheng Rd, Tucheng Dist, New Taipei City 236, Taiwan(R.O.C)
EUT : SATA3 SSD
Model Name : SM220-297 32GB 8192Mx8*4
Model Differences : N/A

Is herewith confirmed to comply with the requirements set out in the FCC Rules and Regulations Part 15 Subpart B and CISPR PUB. 22 and the measurement procedures were according to ANSI C63.4-2014. The said equipment in the configuration described in this report shows the maximum emission levels emanating from equipment are within the compliance requirements.

FCC part 15 subpart B

Class B

Receipt Date : 06/24/2016

Final Test Date : 07/06/2016

Tested By:

Reviewed by:

Jul.6 , 2016

Jul. 6, 2016

Date

Bell Wei/ Engineer

Date

Mike Lee / Manager

Designation Number: TW1083



1.1 DESCRIPTION OF THE TESTED SAMPLES

EUT

EUT Type : Engineer Type
Condition when received : Good
EUT Name : SATA3 SSD
Model Number : SM220-297 32GB 8192Mx8*4
Receipt Date : Jun.24 , 2016
EUT Power Rating : AC Power
 DC Power
 DCV from PC
 DCV from Adaptor
I/O Port of EUT : N/A

1.2 SUMMARY OF TEST RESULT

Emission		
Test Standard	Test Item	Test Result
FCC Part 15B Class B	Conducted Emission	Pass
FCC Part 15B Class B	Radiated Emission	Pass



1.3 TEST METHODOLOGY

EUT SYSTEM OPERATION

1. The EUT was configured according to ANSI C63.4 – 2014 Section 5.2, 7.1, 7.2 & FCC PART 15.
2. Photos of test configuration please refer to appendix 1.
3. Perform the EMC testing procedures, and measure the maximum emission noise.



1.4 DESCRIPTION OF THE SUPPORT EQUIPMENTS

Setup Diagram

See test photographs attached in appendix I for the actual connections between EUT and support equipment.

Support Equipment

Peripherals Devices:

OUTSIDE SUPPORT EQUIPMENT							
No.	Equipment	Model	Serial No.	FCC ID/ BSMI ID	Trade name	Data Cable	Power Cord
1.	PC	D13M	FZHBW02	R33002	DELL	N/A	Unshielded 1.8m
2.	Monitor	EW0430-B	ETY8C02061 SL0	R43002	BENQ	Shielded 1.8m	Unshielded 1.8m
3.	Printer	D4360	N/A	R33001	HP	Shielded 1.8m / USB	Unshielded 1.8m
4.	USB Flash	8G	1423146A016N ARG01S	D32210	TOSHIBA	Shielded 1m	N/A
5.	Mouse	SM-2022	672652-001	T3A062	HP	Shielded 1.8m / USB	N/A
6.	Keyboard	KB-1156	672646-AB3 TW	D33001	HP	Shielded 1.6m / PS2	N/A

Note: All the above equipment /cable were placed in worse case position to maximize emission signals during emission test.

Grounding: Grounding was in accordance with the manufacturer's requirement and conditions for the intended use.

1.5 FEATURES OF EUT: PLEASE REFER TO USER MANUAL OR PRODUCT SPECIFICATION.



2. INSTRUMENT AND CALIBRATION

2.1 MEASURING INSTRUMENT CALIBRATION

The measuring equipment utilized to perform the tests documented in the report has been calibrated once a year or in accordance with the manufacturer's recommendations, and is traceable to recognized national standards.

2.2 TEST AND MEASUREMENT EQUIPMENT

The following list contains measurement equipment used for testing. The equipment conforms to the requirement of CISPR 16-1, ANSI C63.2 and. Other required standards.

Calibration of all test and measurement, including any accessories that may effect such calibration, is checked frequently to ensure the accuracy. Adjustments are made and correction factors are applied in accordance with the instructions contained in the respective.

TABLE LIST OF TEST AND MEASUREMENT EQUIPMENT

Test Site	Instrument	Manufacturer	Model No.	S/N	Next Cal. Date	Cal. Interval
Conduction	Receiver	R&S	ESHS10	830223/008	Nov. 23, 2016	1 Year
	Spectrum Analyzer	ADVANTEST	R3261C	87120343	Mar. 18, 2017	1 Year
	RF Cable	MIYAZAKI & Anritsu	RG58A0 & MP59B	M79094	Apr. 08, 2017	1 Year
	L.I.S.N	Rolf Heine Hochfrequenztechnik	NNB-2/16z	98062	Jan. 16, 2017	1 Year
	EMI Test Receiver	R&S	EAHS-10	1093.4495.03	Mar. 21, 2017	1 Year
	Click Analyzer	Schaffner	DIA1512C	5218	Jun. 15, 2017	1 Year
Radiation	Spectrum (9K--40GHz)	AGILENT	8564EC	4046A0032	Jan. 03, 2017	1 Year
	Antenna	Schwarzbeck	VULB 9161	4077	Feb. 02, 2017	1 Year
	RF Cable	N/A	N/A	N/A	Jan. 18, 2017	1 Year
	Pre-Amp	Schaffner	CPA-9232	1012	Jan. 20, 2017	1 Year
Software	e3	AUDIX	N/A	N/A	N/A	



2.3 TEST PERFORMED

Conducted emissions were investigated over the frequency range from 0.15 MHz to 30 MHz using a receiver which bandwidth is set at 9 KHz.

Radiated emissions were investigated over the frequency range from 30 MHz to 1000 MHz using a receiver which bandwidth is set at 120 KHz. Radiated measurement was performed at distance that from an antenna to EUT is 10 meters.



2.4 APPENDIX

Appendix A: Measurement Procedure for Main Power Port Conducted Emissions

The measurements are performed in a WH lab room; The EUT was placed on non-conductive 1.0m x 1.5m table, which is 0.8 meters above an earth-grounded.

Power to the EUT was provided through the LISN which has the Impedance (50 ohm/50 uH) vs. Frequency Characteristic in accordance with the standard. Powers to the LISNs were filtered to eliminate ambient signal interference and these filters were bonded to the ground plane. Peripheral equipment required to provide a functional system (support equipment) for EUT testing was powered from the second LISN through a ganged, metal power outlet box which is bonded to the ground plane at the LISN.

If the EUT is supplied with a flexible power cord, the power cord length in excess of the distance separating the EUT from the LISN shall be folded back and forth at the center of the lead so as to form a bundle not exceeding 40 cm in length. If the EUT is provided with a permanently coiled power cord, bundling of the cord is not required. If the EUT is supplied without a power cord, the EUT shall be connected to the LISN by a power cord of the type specified by the manufacturer which shall not be longer than 1 meter. The excess power cord shall be bundled as described above. If a non-flexible power cord is provided with the EUT, it shall be cut to the length necessary to attach the EUT to the LISN and shall not be bundled.

The interconnecting cables were arranged and moved to get the maximum measurement. Both the line of power cord, hot and neutral, was measured.

The highest emissions were analyzed in details by operating the spectrum analyzer in fixed tuned mode to determine the nature of the emissions and to provide information which could be useful in reducing their amplitude.

Appendix B: Test Procedure for Radiated Emissions

Preliminary Measurements in the Anechoic Chamber

The radiated emissions are initially measured in the anechoic chamber at a measurement distance of 3 meters. Desktop EUT are placed on a wooden stand 0.8 meter in height. The measurement antenna is 3 meters from the EUT. The test setup in anechoic chamber is the same as open site. The turntable rotated 360°. The antenna height is 1m. The primary objective of the radiated measurements in the anechoic chamber is to identify the frequency spectrum in the absence of the electromagnetic environment existing on the open test site. The frequencies can then be pre-selected on the open test site to obtain the corresponding amplitude. The initial scan is made with the spectrum analyzer in automatic sweep mode. The spectrum peaks are then measured manually to determine the exact frequencies.



Measurements on the Open Site or Chamber

The radiated emissions test will then be repeated on the open site or chamber to measure the amplitudes accurately and without the multiple reflections existing in the shielded room. The EUT and support equipments are set up on the turntable. Desktop EUT are set up on a wooden stand 0.8 meter above the ground.

For the initial measurements, the receiving antenna is varied from 1-4 meter height and is changed in the vertical plane from vertical to horizontal polarization at each frequency. Both reading are recorded with the quasi-peak detector with 120 KHz bandwidth. For frequency between 30 MHz and 1000 MHz, the reading is recorded with peak detector or quasi-peak detector.

At the highest amplitudes observed, the EUT is rotated in the horizontal plane while changing the antenna polarization in the vertical plane to maximize the reading. The interconnecting cables were arranged and moved to get the maximum measurement. Once the maximum reading is obtained, the antenna elevation and polarization will be varied between specified limits to maximize the readings.



Appendix C: Warning Labels

Label Requirements

A Class B digital device subject to certification by the FCC shall carry a warning label which includes the following statement:

***** WARNING *****

This device complies with Part 15 of the FCC Rules. Operation is subject to the following two conditions: (1) this device may not cause harmful interference, and (2) this device must accept any interference received, including interference that may cause undesired operation.

Appendix D: Warning Statement

Statement Requirements

The operator's manual for a Class A digital device shall contain the following statements or their equivalent:

***** WARNING *****

This equipment has been tested and found to comply with the limits for a Class A digital device, pursuant to part 15 of the FCC Rules. These limits are designed to provide reasonable protection against harmful interference when the equipment is operated in a commercial environment. This equipment generates, uses, and can radiate radio frequency energy and, if not installed and used in accordance with the instruction manual, may cause harmful interference to radio communications. Operation of this equipment in a residential area is likely to cause harmful interference in which case the user will be required to correct the interference at his own expense.

Notice: The changes or modifications not expressly approved by the party responsible for compliance could void the user's authority to operate the equivalent.

* * * * *

If the EUT was tested with special shielded cables the operator's manual for such product shall also contain the following statements or their equivalent:

Shielded interface cables and/or AC power cord, if any, must be used in order to comply with the emission limits.



3. CONDUCTED EMISSION MEASUREMENT

3.1 TEST SET-UP (PLEASE REFER TO APPENDIX 1)

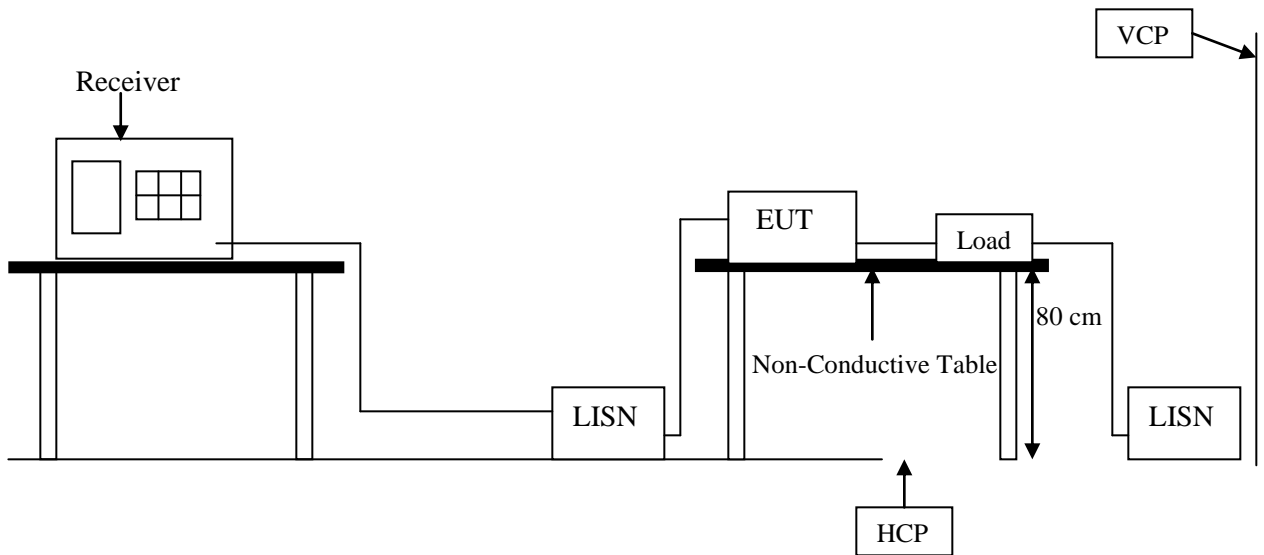

3.2 LIMIT

Frequency range (MHz)	CLASS A		CLASS B	
	QP dB(uV)	Average dB(uV)	QP dB(uV)	Average dB(uV)
0.15-0.5	79 dBuV	66 dBuV	66 - 56 dBuV	56 - 46 dBuV
0.5-5.0	73 dBuV	60 dBuV	56 dBuV	46 dBuV
5.0-30.0	73 dBuV	60 dBuV	60 dBuV	50 dBuV

Remark: In the above table, the tighter limit applies at the band edges.

3.3 TEST PROCEDURE

The EUT and simulators are connected to the main power through a line impedance stabilization network (LISN). It provides a 50 ohm / 50 μH coupling impedance for the measuring equipment. The peripheral devices are also connected to the main power through a LISN that provides a 50 ohm / 50 μH coupling impedance with 50 ohm termination. (Please refer to the block diagram of the test setup and photograph.)

Both sides of AC line are checked for the maximum conducted emission interference. In order to find the maximum emissions, the relating positions of equipment and all of the interference cables must be changed according to FCC



PART 15 regulation: The measurement procedure on conducted emission interference.

The resolution bandwidth of the field strength meter is set at 9KHz

3.4 TEST SPECIFICATION

ANSI C63.4 – 2014 Section 5.2, 7.1, 7.2 & FCC PART 15 CLASS B

3.5 RESULT: PASSED

3.6 TEST DATA:

Please refer to appendix 2.



4. RADIATED EMISSION MEASUREMENT

4.1 TEST SETUP (PLEASE REFER TO APPENDIX 1)

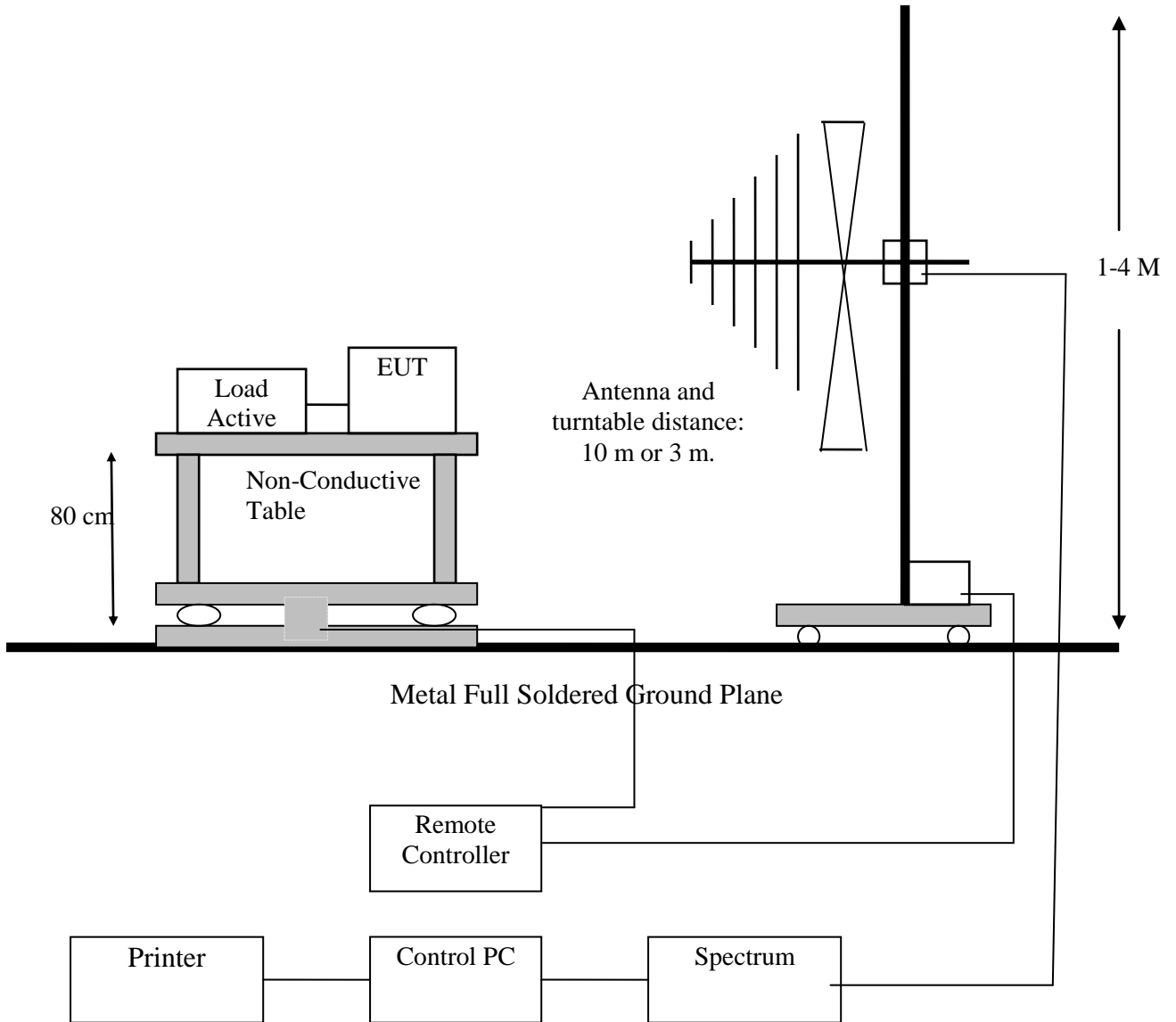



4.2 LIMIT

Frequency	Class A		Class B	
MHz	Distance (Meter)	Limit dB μ V/m	Distance (Meter)	Limit dB μ V/m
30 ~ 230	10	40	10	30
230 ~ 1000	10	47	10	37

Frequency range GHz	Average limit dB(μ V/m)	Peak limit dB(μ V/m)
Above 1000	54	74

Remark: In the above table, the tighter limit applies at the band edges

4.3 TEST PROCEDURE

The EUT and its simulators are placed on turn table, non-conductive and wooden table, which is 0.8 meter above ground. The turn table rotates 360 degrees to determine the position of the maximum emission level. For the frequency range is below 1 GHz, the EUT was positioned such that distance from antenna to the EUT is 10 meters. For the frequency range is above 1 GHz, the EUT was positioned such that distance from antenna to the EUT is 3 meters.

For the frequency range is below 1 GHz, the antenna is moved up and down between 1 meter and 4 meters to receive the maximum emission level.

Both horizontal and vertical polarizations of the antenna are set on measurement. In order to find the maximum emission, all of the interference cables must be manipulated according to FCC regulation: the test procedure of the radiated emission measurement.

The bandwidth set on the field strength is 120 KHz when the frequency range is below 1GHz. The bandwidth set on the field strength is 1 MHz when the frequency range is above 1GHz.

4.4 TEST SPECIFICATION

ANSI C63.4 – 2014 Section 5.2, 7.1, 7.2 & FCC PART 15 CLASS B



4.5 RESULT: PASSED

4.6 TEST DATA:

Please refer to appendix 2.



5. MEASUREMENT UNCERTAINTY

Measurement Item	Measurement Frequency	Polarization	Uncertainty
Conducted Emission	9 kHz ~ 30. MHz	LINE/NEUTRAL	1.78 dB
Radiated Emission	30 MHz ~ 1,000 MHz	Horizontal	3.59 dB
		Vertical	3.89 dB
	1,000 MHz ~ 18GHz	Horizontal	5.00 dB
		Vertical	4.64 dB



SAMPLE OF FCC VERIFICATION LABEL 1

This device complies with part 15 of the FCC Rules. Operation is subject to the following two conditions: (1) This device may not cause harmful interference. And (2) this device must accept any interference received, including interference that may cause undesired operation.

SAMPLE OF FCC DoC LABEL 2

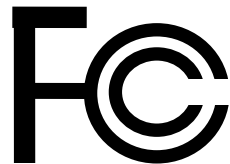

Trade Name
Model Number



APPENDIX 1

PHOTOS OF TEST CONFIGURATION

Photograph – Conducted Emission Test Setup





Photograph – Radiated Emission Test Setup-Below 1GHz





Photograph – Radiated Emission Test Setup-Above 1GHz





APPENDIX 2 TEST DATA

Test Data – Conducted Emission

Phase: L

Date: 2016-07-04

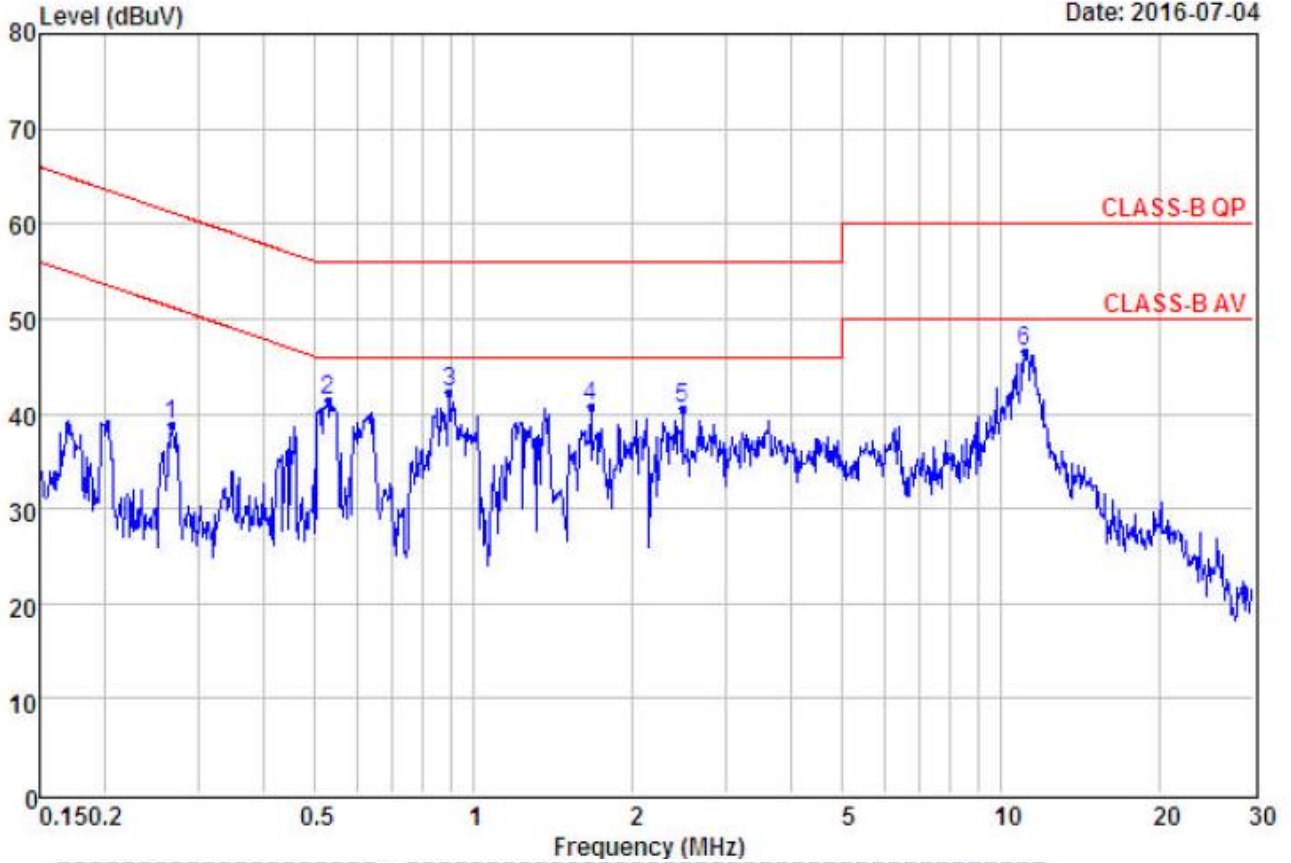

Remarks:

: Factor=Insertion loss+Cable loss

	Freq	Read Level	Level	Factor	Over Limit	Limit Line	Remark
	MHz	dBuV	dBuV	dB	dB	dBuV	
1	0.27	28.66	38.80	10.14	-22.40	61.20	Peak
2	0.53	31.34	41.48	10.14	-14.52	56.00	Peak
3	0.90	32.04	42.20	10.16	-13.80	56.00	Peak
4	1.66	30.56	40.76	10.20	-15.24	56.00	Peak
5	2.49	30.39	40.64	10.25	-15.36	56.00	Peak
6 @	11.08	36.05	46.54	10.49	-13.46	60.00	Peak



Phase: N

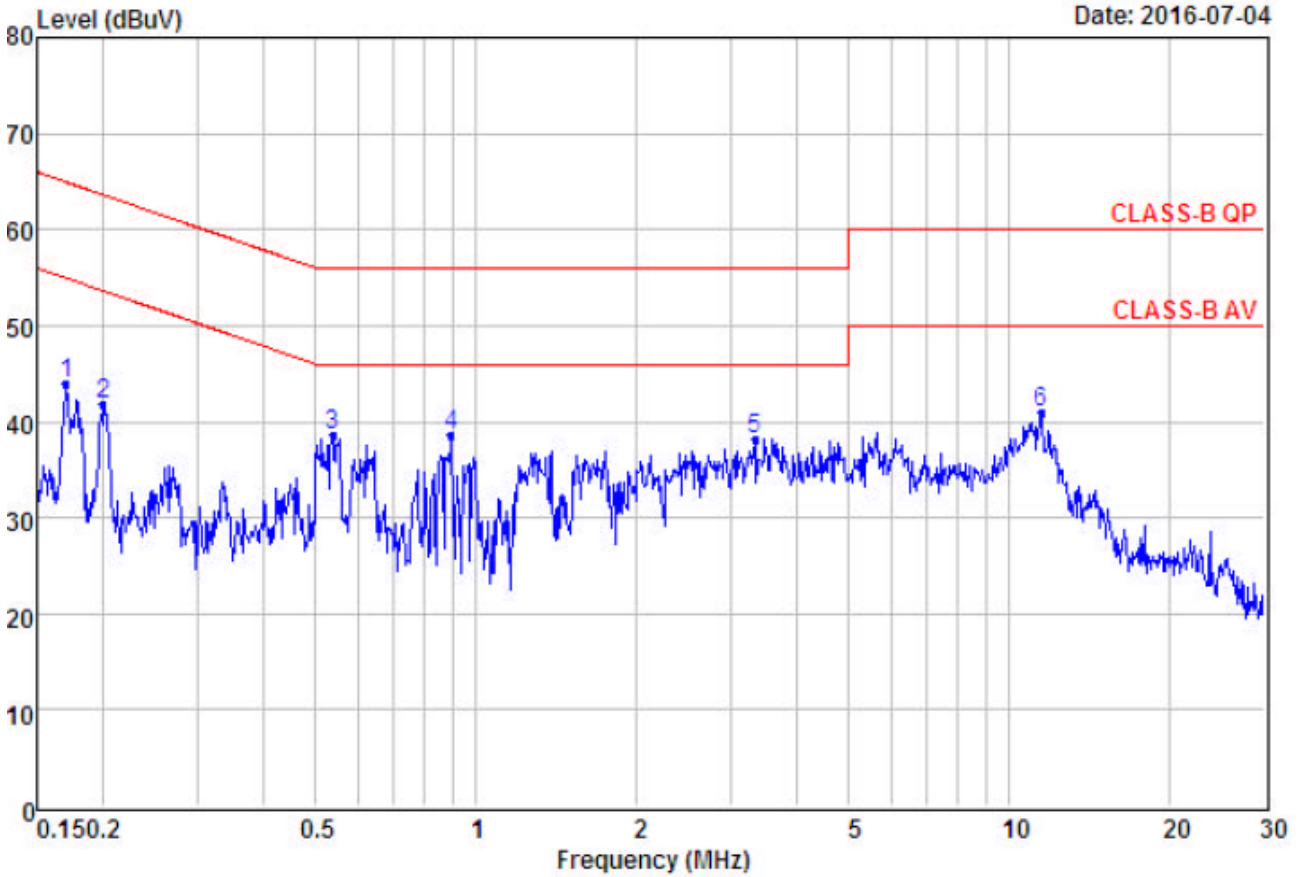

Remarks:

: Factor=Insertion loss+Cable loss

	Read	Over	Limit		Limit	Line	Remark
Freq	Level	Level	Factor	Limit	Line	Line	Remark
MHz	dBuV	dBuV	dB	dB	dBuV		
1	33.82	43.91	10.09	-21.03	64.94		Peak
2	31.66	41.77	10.11	-21.85	63.62		Peak
3	28.34	38.51	10.17	-17.49	56.00		Peak
4 @	28.38	38.59	10.21	-17.41	56.00		Peak
5	27.96	38.21	10.25	-17.79	56.00		Peak
6	30.47	40.92	10.45	-19.08	60.00		Peak



Test Data – Radiated Emission-Below 1GHz

Polarization: Horizontal

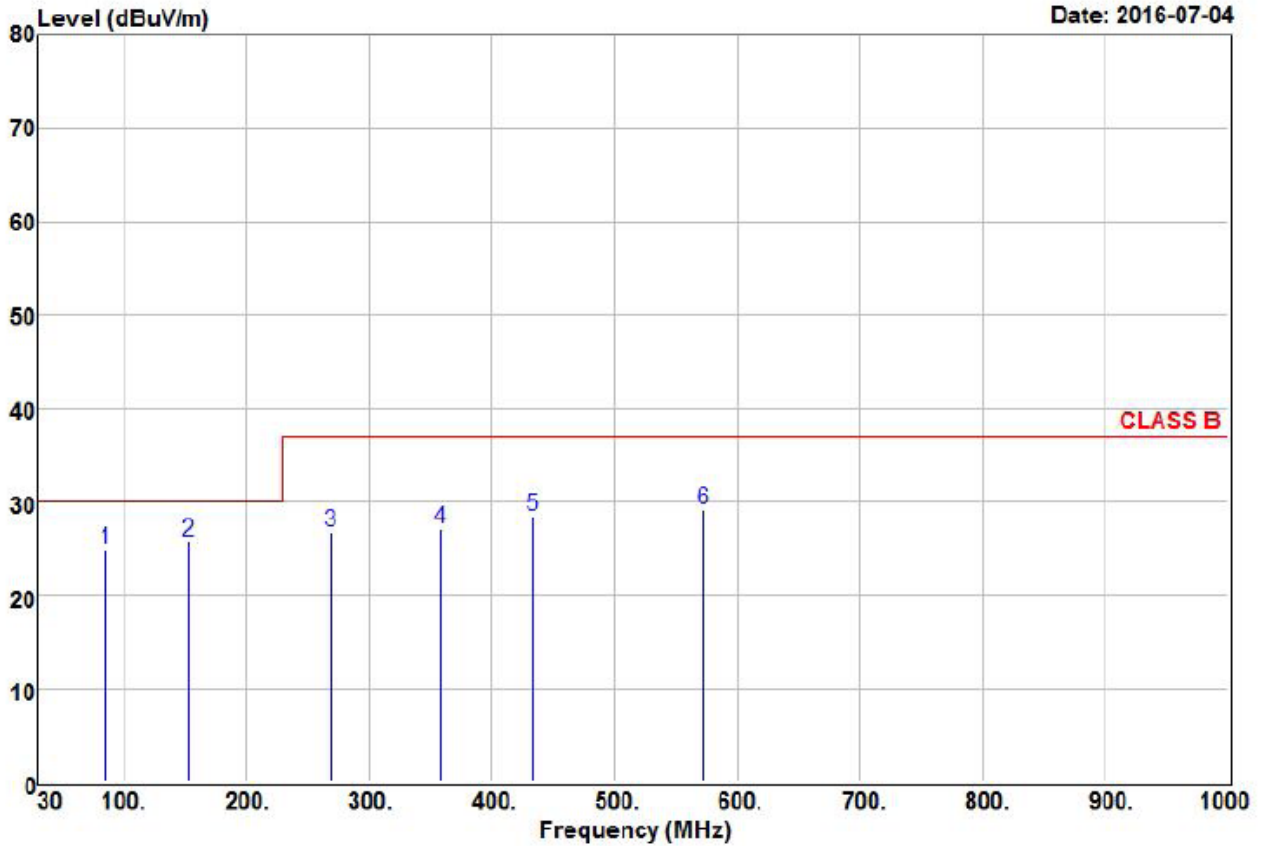

Remarks: : 1.Result=Read Value+Factor
: 2.Factor=Antenna Factor+Cable loss-
: Amplifier Factor

	Freq	Level	Read Level	Factor	Over Limit	Limit	Remark
	MHz	dBuV/m	dBuV	dB/m	dB	dBuV/m	
1	85.41	24.77	44.71	-19.94	-5.23	30.00	QP
2 @	153.47	25.66	37.18	-11.52	-4.34	30.00	QP
3	269.47	26.66	42.17	-15.51	-10.34	37.00	QP
4	358.96	27.11	40.17	-13.06	-9.89	37.00	QP
5	434.23	28.41	39.01	-10.60	-8.59	37.00	QP
6	573.11	29.11	36.98	-7.87	-7.89	37.00	QP



Polarization: Vertical

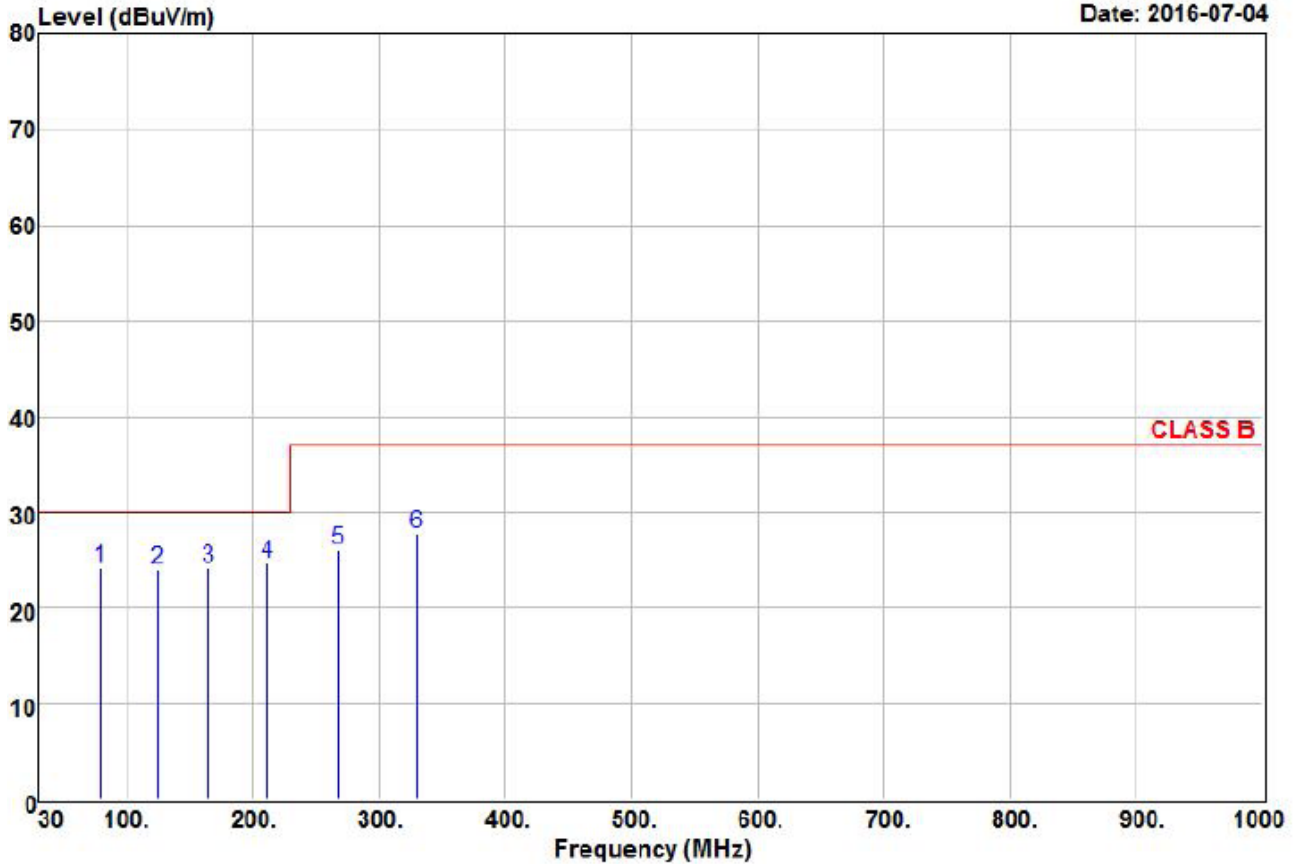

Remarks: : 1.Result=Read Value+Factor
: 2.Factor=Antenna Factor+Cable loss-
: Amplifier Factor

	Freq	Level	Read	Over	Limit	Limit	Remark
	MHz	dBuV/m	Level	Factor	Limit	Line	
			dBuV	dB/m	dB	dBuV/m	
1	79.22	24.11	45.27	-21.16	-5.89	30.00	QP
2	124.53	23.99	40.25	-16.26	-6.01	30.00	QP
3	165.47	24.11	35.28	-11.17	-5.89	30.00	QP
4 @	211.63	24.66	40.11	-15.45	-5.34	30.00	QP
5	267.14	26.11	41.74	-15.63	-10.89	37.00	QP
6	329.63	27.77	41.59	-13.82	-9.23	37.00	QP

Test Data – Radiated Emission-Above 1GHz



Polarization: Horizontal

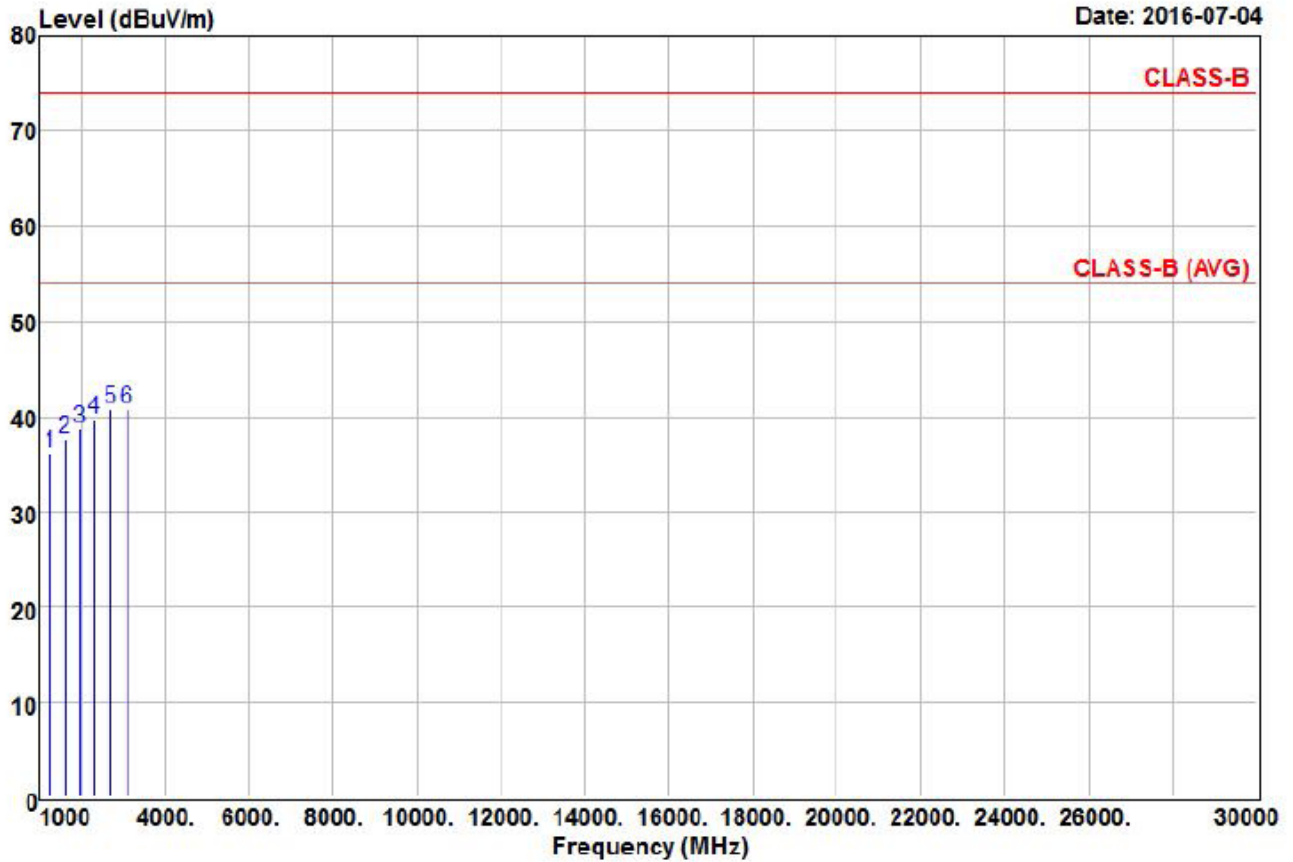

Remarks : 1.Result=Read Value+Factor
: 2.Factor=Antenna Factor+Cable loss-
: Amplifier Factor

	Freq	Level	Read Level	Factor	Over Limit	Limit	Remark
	MHz	dBuV/m	dBuV	dB/m	dB	dBuV/m	
1	1283.00	36.21	55.55	-19.34	-37.79	74.00	Peak
2	1627.00	37.74	55.47	-17.73	-36.26	74.00	Peak
3	1962.00	38.74	54.57	-15.83	-35.26	74.00	Peak
4	2317.00	39.74	54.36	-14.62	-34.26	74.00	Peak
5	2724.00	40.74	53.71	-12.97	-33.26	74.00	Peak
6 @	3105.00	40.77	52.22	-11.45	-33.23	74.00	Peak



Polarization: Vertical

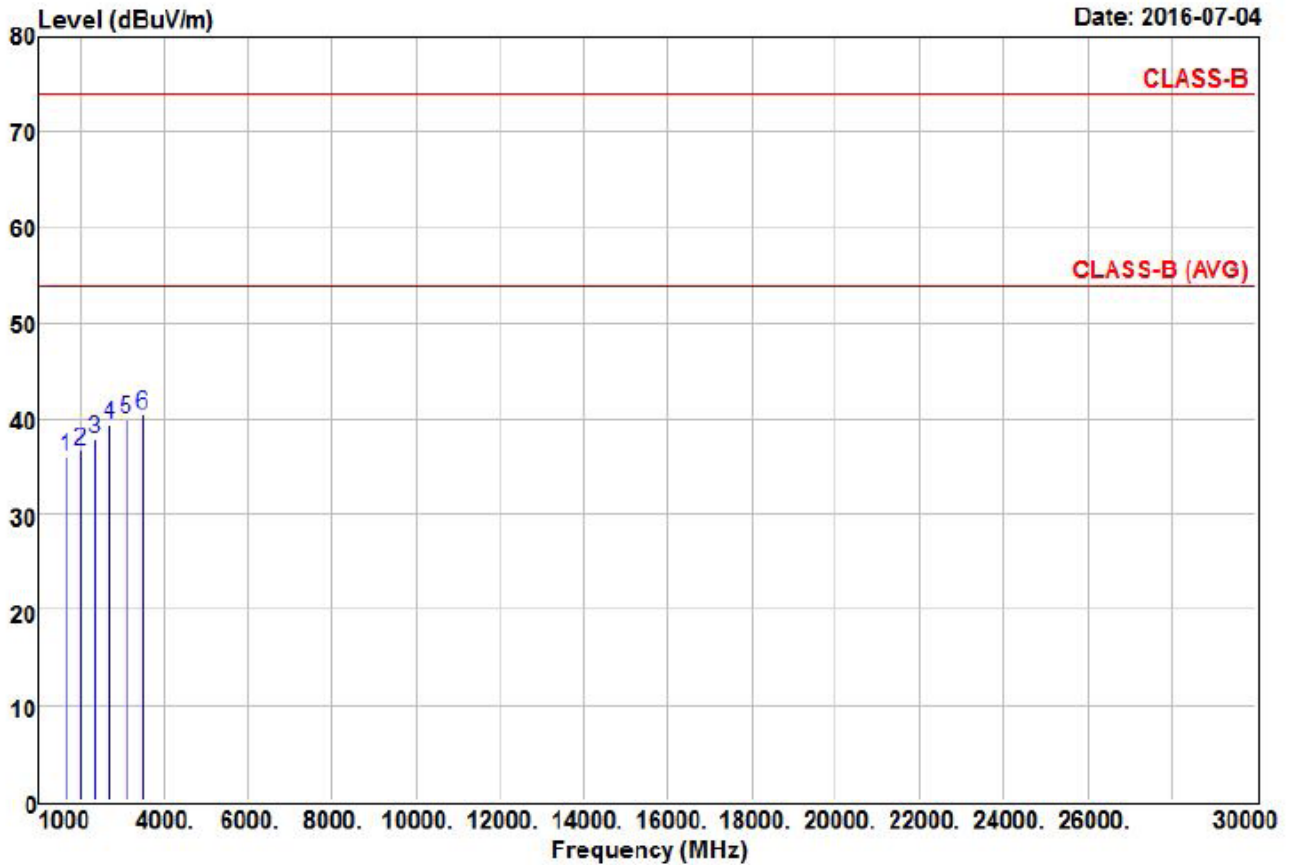

Remarks: : 1.Result=Read Value+Factor
: 2.Factor=Antenna Factor+Cable loss-
: Amplifier Factor

	Freq	Level	Read	Over	Limit		
	MHz	dBuV/m	Level	Factor	Limit	Line	
			dBuV	dB/m	dB	dBuV/m	
1	1657.00	35.97	53.53	-17.56	-38.03	74.00	Peak
2	2006.00	36.75	52.34	-15.59	-37.25	74.00	Peak
3	2351.00	37.87	52.39	-14.52	-36.13	74.00	Peak
4	2714.00	39.36	52.38	-13.02	-34.64	74.00	Peak
5	3089.00	39.88	51.36	-11.48	-34.12	74.00	Peak
6 @	3497.00	40.44	51.10	-10.66	-33.56	74.00	Peak



PHOTOS OF EUT

