



CERTIFICATE

Issued Date: Nov. 27, 2013
Report No.: 13B0432R-ITCEP03V00

This is to certify that the following designated product

Product : SATA Flash Drive
Trade name : Apacer
Model Number : SFD25A(-M) 7mm HighSpeed
Company Name : Apacer Technology Inc.

This product, which has been issued the test report listed as above in QuietTek Laboratory, is based on a single evaluation of one sample and confirmed to comply with the requirements of the following EMC standard.

EN 55022: 2010+AC: 2011

EN 61000-3-2: 2006+A2: 2009

EN 61000-3-3: 2008

EN 55024: 2010

IEC 61000-4-2 Ed. 2.0: 2008

IEC 61000-4-3 Ed. 3.2: 2010

IEC 61000-4-4 Ed. 3.0: 2012

IEC 61000-4-5 Ed. 2.0: 2005

IEC 61000-4-6 Ed. 3.0: 2008

IEC 61000-4-8 Ed. 2.0: 2009

IEC 61000-4-11 Ed. 2.0: 2004

TEST LABORATORY

Vincent Lin / Director

CE Test Report

Product Name : SATA Flash Drive
Model No. : SFD25A(-M) 7mm HighSpeed

Applicant : Apacer Technology Inc.
Address : 1F., No.32, Zhongcheng Rd., Tucheng Dist., New Taipei
City 236, Taiwan (R.O.C)

Date of Receipt : 2013/11/21
Issued Date : 2013/11/27
Report No. : 13B0432R-ITCEP03V00
Report Version : V1.0



The test results relate only to the samples tested.

The test results shown in the test report are traceable to the national/international standard through the calibration of the equipment and evaluated measurement uncertainty herein.

This report must not be used to claim product endorsement by TAF or any agency of the Government

The test report shall not be reproduced except in full without the written approval of Quietek Corporation.

CE Declaration of Conformity

We herewith confirm the following designated products to comply with the requirements set out in the Council Directive on the approximation of the laws of the Member States relating to Electromagnetic Compatibility Directive (2004/108/EC) with applicable standards listed below.

Product : SATA Flash Drive
Trade name : Apacer
Model Number : SFD25A(-M) 7mm HighSpeed
Applicable Harmonized : EN 55022: 2010+AC: 2011, Class B
Standards under Directive : EN 55024: 2010
2004/108/EC : EN 61000-3-2: 2006+A2: 2009
EN 61000-3-3: 2008

Company Name : _____

Company Address : _____

Telephone : _____ Facsimile : _____

Person in responsible for marking this declaration:

Name (Full Name)

Title/ Department

Date

Legal Signature

CE Statement of Conformity

This statement is to certify that the designated product below.

Product : SATA Flash Drive
Trade name : Apacer
Model Number : SFD25A(-M) 7mm HighSpeed
Company Name : Apacer Technology Inc.
Applicable Standards : EN 55022: 2010+AC: 2011, Class B
EN 55024: 2010
EN 61000-3-2: 2006+A2: 2009
EN 61000-3-3: 2008

One sample of the designated product has been tested and evaluated in our laboratory to find in compliance with the applicable standards above. The issued test report(s) show(s) it in detail.

Report Number : 13B0432R-ITCEP03V00

TEST LABORATORY



Vincent Lin / Director

The verification is based on a single evaluation of one sample of above-mentioned products. It does not imply an assessment of the whole production and does not permit the use of the test lab. Logo.

Test Report Certification

Issued Date : 2013/11/27

Report No. : 13B0432R-ITCEP03V00



Product Name : SATA Flash Drive
 Applicant : Apacer Technology Inc.
 Address : 1F., No.32, Zhongcheng Rd., Tucheng Dist., New Taipei City
 236, Taiwan (R.O.C)
 Manufacturer : Apacer Technology Inc.
 Model No. : SFD25A(-M) 7mm HighSpeed
 EUT Rated Voltage : Power by PC
 EUT Test Voltage : AC 230 V / 50 Hz
 Trade Name : Apacer
 Applicable Standard : EN 55022: 2010+AC: 2011, Class B
 EN 55024: 2010
 EN 61000-3-2: 2006+A2: 2009
 EN 61000-3-3: 2008
 Test Result : Complied
 Performed Location : Quietek Corporation (Linkou Laboratory)
 No.5-22, Ruishukeng, Linkou Dist., New Taipei City 24451,
 Taiwan, R.O.C.
 TEL:+866-2-8601-3788 / FAX:+886-2-8601-3789

Documented By : Anny Chou
 (Adm. Specialist / Anny Chou)

Reviewed By : Wright Tsai
 (Engineer / Wright Tsai)

Approved By : Vincent Lin
 (Director / Vincent Lin)

Laboratory Information

We, **QuieTek Corporation**, are an independent EMC and safety consultancy that was established the whole facility in our laboratories. The test facility has been accredited/accepted (audited or listed) by the following related bodies in compliance with ISO 17025, EN 45001 and specified testing scopes:

Taiwan R.O.C.	:	BSMI, NCC, TAF
Norway	:	Nemko
USA	:	FCC
Japan	:	VCCI

The related certificate for our laboratories about the test site and management system can be downloaded from QuieTek Corporation's Web Site : <http://www.quietek.com/tw/ctg/cts/accreditations.htm>

The address and introduction of QuieTek Corporation's laboratories can be founded in our Web site : <http://www.quietek.com/>

If you have any comments, Please don't hesitate to contact us. Our contact information is as below:

HsinChu Testing Laboratory :

No.75-2, 3rd Lin, Wangye Keng, Yonghxing Tsuen, Qionglin Shiang, Hsinchu County 307, Taiwan, R.O.C.

TEL:+886-3-592-8858 / FAX:+886-3-592-8859 E-Mail : service@quietek.com

LinKou Testing Laboratory :

No.5-22, Ruishukeng, Linkou Dist., New Taipei City 24451, Taiwan, R.O.C.

TEL : 886-2-8601-3788 / FAX : 886-2-8601-3789 E-Mail : service@quietek.com

Suzhou (China) Testing Laboratory :

No. 99 Hongye Rd., Suzhou Industrial Park Loufeng Hi-Tech Development Zone., Suzhou,China.

TEL : +86-512-6251-5088 / FAX : +86-512-6251-5098 E-Mail : service@quietek.com

TABLE OF CONTENTS

Description	Page
1. General Information	7
1.1. EUT Description.....	7
1.2. Mode of Operation	7
1.3. Tested System Details	8
1.4. Configuration of Tested System	9
1.5. EUT Exercise Software.....	10
2. Technical Test	11
2.1. Summary of Test Result.....	11
2.2. List of Test Equipment	12
2.3. Measurement Uncertainty.....	14
2.4. Test Environment.....	16
3. Conducted Emission (Main Terminals).....	17
3.1. Test Specification	17
3.2. Test Setup.....	17
3.3. Limit	17
3.4. Test Procedure	18
3.5. Deviation from Test Standard.....	18
3.6. Test Result	19
3.7. Test Photograph	25
4. Radiated Emission	26
4.1. Test Specification	26
4.2. Test Setup.....	26
4.3. Limit	27
4.4. Test Procedure	28
4.5. Deviation from Test Standard.....	28
4.6. Test Result	29
4.7. Test Photograph	33
5. Harmonic Current Emission	35
5.1. Test Specification	35
5.2. Test Setup.....	35
5.3. Limit	35
5.4. Test Procedure	37
5.5. Deviation from Test Standard.....	37
5.6. Test Result.....	38
5.7. Test Photograph	40
6. Voltage Fluctuation and Flicker	41

6.1.	Test Specification	41
6.2.	Test Setup.....	41
6.3.	Limit.....	41
6.4.	Test Procedure	42
6.5.	Deviation from Test Standard.....	42
6.6.	Test Result.....	43
6.7.	Test Photograph	44
7.	Electrostatic Discharge	45
7.1.	Test Specification	45
7.2.	Test Setup.....	45
7.3.	Limit.....	45
7.4.	Test Procedure	46
7.5.	Deviation from Test Standard.....	46
7.6.	Test Result.....	47
7.7.	Test Photograph	48
8.	Radiated Susceptibility	49
8.1.	Test Specification	49
8.2.	Test Setup.....	49
8.3.	Limit.....	49
8.4.	Test Procedure	50
8.5.	Deviation from Test Standard.....	50
8.6.	Test Result.....	51
8.7.	Test Photograph	52
9.	Electrical Fast Transient/Burst	53
9.1.	Test Specification	53
9.2.	Test Setup.....	53
9.3.	Limit.....	53
9.4.	Test Procedure	54
9.5.	Deviation from Test Standard.....	54
9.6.	Test Result.....	55
9.7.	Test Photograph	56
10.	Surge	57
10.1.	Test Specification	57
10.2.	Test Setup.....	57
10.3.	Limit.....	57
10.4.	Test Procedure	59
10.5.	Deviation from Test Standard.....	59
10.6.	Test Result.....	60

10.7.	Test Photograph	61
11.	Conducted Susceptibility	62
11.1.	Test Specification	62
11.2.	Test Setup.....	62
11.3.	Limit.....	63
11.4.	Test Procedure	63
11.5.	Deviation from Test Standard.....	63
11.6.	Test Result.....	64
11.7.	Test Photograph	65
12.	Power Frequency Magnetic Field	66
12.1.	Test Specification	66
12.2.	Test Setup.....	66
12.3.	Limit.....	66
12.4.	Test Procedure	66
12.5.	Deviation from Test Standard.....	66
12.6.	Test Result.....	67
12.7.	Test Photograph	68
13.	Voltage Dips and Interruption.....	69
13.1.	Test Specification	69
13.2.	Test Setup.....	69
13.3.	Limit.....	69
13.4.	Test Procedure	70
13.5.	Deviation from Test Standard.....	70
13.6.	Test Result.....	71
13.7.	Test Photograph	72
14.	Attachment	73
	EUT Photograph.....	73

1. General Information

1.1. EUT Description

Product Name	SATA Flash Drive
Trade Name	Apacer
Model No.	SFD25A(-M) 7mm HighSpeed

1.2. Mode of Operation

Quietek has verified the construction and function in typical operation. All the test modes were carried out with the EUT in normal operation, which was shown in this test report and defined as:

Pre-Test Mode	
Mode 1: Normal Operation	
Final Test Mode	
Emission	Mode 1: Normal Operation
Immunity	Mode 1: Normal Operation

1.3. Tested System Details

The types for all equipments, plus descriptions of all cables used in the tested system (including inserted cards) are:

Product	Manufacturer	Model No.	Serial No.	Power Cord	
1	Monitor (EMI)	DELL	U2410f	CN-082WXD-72872-1AV-AD8L	Non-Shielded, 1.8m
	Monitor (EMS)	LG	W2261VT	907YHZK07373	Non-Shielded, 1.8m
2	PC	DELL	Vostro230	1R7Z62S	Non-Shielded, 1.8m
3	Printer	EPSON	StyLus C63	FAPY012396	Non-Shielded, 1.8m
4	Modem	ACEEX	DM-1414	0102027556	Non-Shielded, 1.8m
5	iPod nano	Apple	A1236	7K823DY0Y0P	N/A
6	Microphone & Earphone	Ergotech	ET-E201	N/A	N/A
7	Keyboard	Logitech	Y-SM46	867404-0121	N/A
8	Mouse	Logitech	M-SBM96B	810-000439	N/A

1.4. Configuration of Tested System

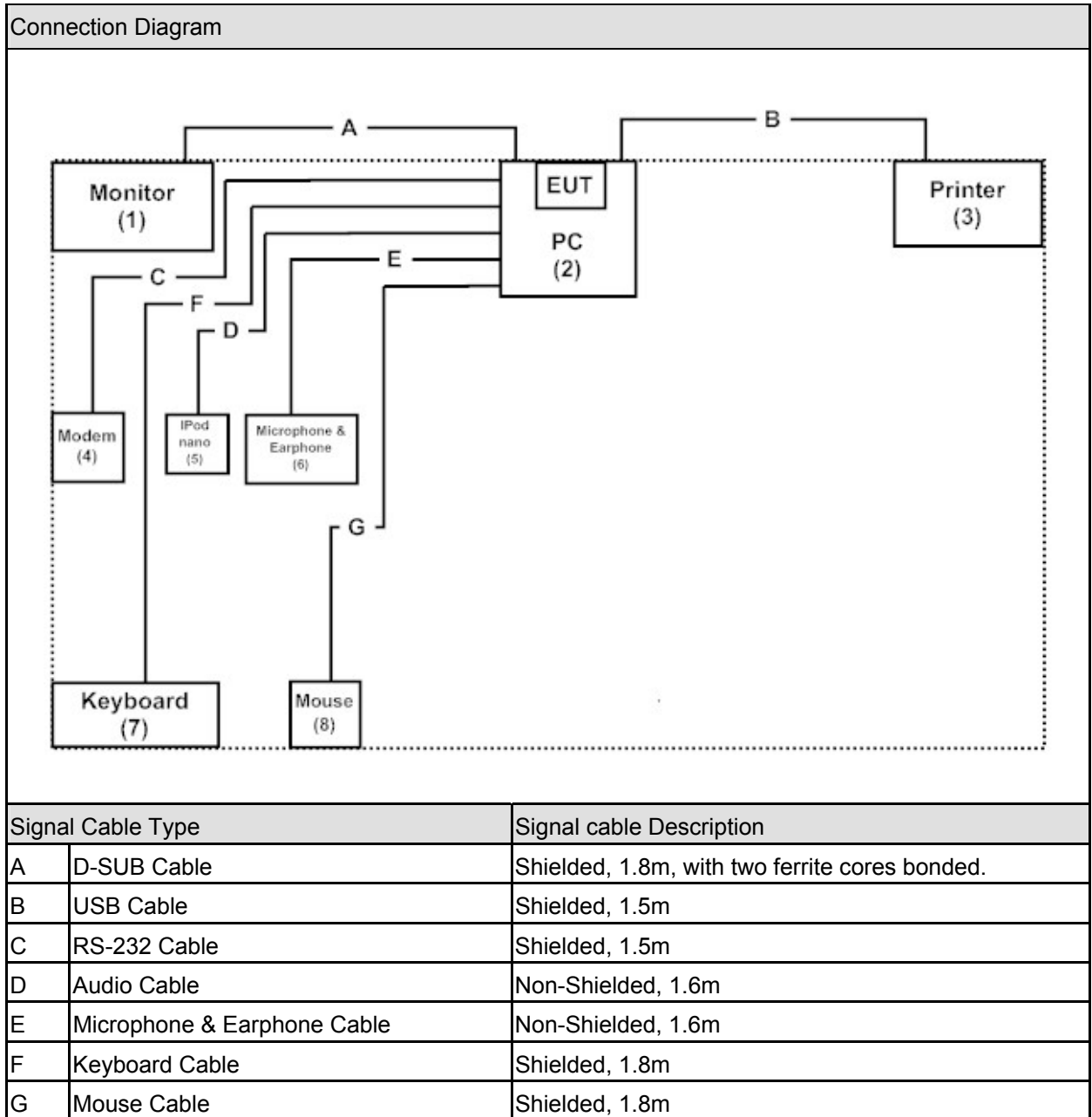

1.5. EUT Exercise Software

1	Setup the EUT and simulators as shown on 1.4.
2	Turn on the power of all equipments.
3	All the features of the EUT operation normally.

2. Technical Test

2.1. Summary of Test Result

- No deviations from the test standards
 Deviations from the test standards as below description:

Emission			
Performed Item	Normative References	Test Performed	Deviation
Conducted Emission	EN 55022: 2010+AC: 2011	Yes	No
Impedance Stabilization Network	EN 55022: 2010+AC: 2011	No	No
Radiated Emission	EN 55022: 2010+AC: 2011	Yes	No
Power Harmonics	EN 61000-3-2: 2006+A2: 2009	Yes	No
Voltage Fluctuation and Flicker	EN 61000-3-3: 2008	Yes	No

Immunity			
Performed Item	Normative References	Test Performed	Deviation
Electrostatic Discharge	IEC 61000-4-2 Ed. 2.0: 2008	Yes	No
Radiated susceptibility	IEC 61000-4-3 Ed. 3.2: 2010	Yes	No
Electrical fast transient/burst	IEC 61000-4-4 Ed. 3.0: 2012	Yes	No
Surge	IEC 61000-4-5 Ed. 2.0: 2005	Yes	No
Conducted susceptibility	IEC 61000-4-6 Ed. 3.0: 2008	Yes	No
Power frequency magnetic field	IEC 61000-4-8 Ed. 2.0: 2009	Yes	No
Voltage dips and interruption	IEC 61000-4-11 Ed. 2.0: 2004	Yes	No

2.2. List of Test Equipment

Conducted Emission / SR8

Instrument	Manufacturer	Type No.	Serial No	Cal. Date
EMI Test Receiver	R&S	ESCS 30	100369	2013/09/14
LISN	R&S	ESH3-Z5	836679/017	2013/01/16
LISN	R&S	ENV216	100097	2013/01/16
Coaxial Cable	QTK(Arnist)	RG 400	LC018-RG	2013/06/26

Radiated Emission / Site7

Instrument	Manufacturer	Type No.	Serial No	Cal. Date
Bilog Antenna	Schaffner Chase	CBL6112B	2930	2013/05/06
EMI Test Receiver	R&S	ESCI	100649	2013/04/18
Coaxial Cable	QTK(Arnist)	RG 214	LC007-RG	2013/06/23
Site7 NSA	QTK	N/A	N/A	2013/06/23
Pre-Amplifier	QTK	AP/0100A	CHM/1009094	2013/06/23

Radiated Emission / CB7

Instrument	Manufacturer	Type No.	Serial No	Cal. Date
EMI Test Receiver	R&S	ESU26	100433	2013/07/29
Horn Antenna	ETS-Lindgren	3117	00135205	2013/03/26
Horn Antenna	SCHWARZBECK	9120D	576	2013/11/19
Pre-Amplifier	Quietek	AP-180C	CHM/071920	2013/06/24
CB7 VSWR	QTK	N/A	N/A	2013/07/25

Power Harmonics / SR3

Instrument	Manufacturer	Type No.	Serial No	Cal. Date
AC Power Source(Harmonic)	Schaffner	NSG 1007	HK54148	2013/10/25
IEC1000-4-X Analyzer(Flicker)	Schaffner	CCN 1000-1	X7 1887	2013/10/25

Voltage Fluctuation and Flicker / SR3

Instrument	Manufacturer	Type No.	Serial No	Cal. Date
AC Power Source(Harmonic)	Schaffner	NSG 1007	HK54148	2013/10/25
IEC1000-4-X Analyzer(Flicker)	Schaffner	CCN 1000-1	X7 1887	2013/10/25

Electrostatic Discharge / SR6

Instrument	Manufacturer	Type No.	Serial No	Cal. Date
ESD Simulator System	Noiseken	ESS2002EX	ESS0929057	2013/06/21
ESD GUN	Noiseken	TC-815R	ESS0929097	2013/06/21
Horizontal Coupling Plane(HCP)	Quietek	HCP AL50	N/A	N/A
Vertical Coupling Plane(VCP)	Quietek	VCP AL50	N/A	N/A

Radiated susceptibility / CB5

Instrument	Manufacturer	Type No.	Serial No	Cal. Date
AF-BOX	R&S	AF-BOX ACCUST	100007	N/A
Audio Analyzer	R&S	UPL 16	100137	2013/05/09
Biconilog Antenna	EMCO	3149	00071675	N/A
Directional Coupler	A&R	DC 6180	22735	N/A
Power Amplifier	A&R	30S1G3	309453	N/A
Power Amplifier	A&R	100W10000M7	A285000010	N/A
Power Amplifier	SCHAFFNER	CBA9413B	4020	N/A
Power Amplifier	AR	75A250A	0325371	N/A
Power Meter	R&S	NRVD(P.M)	100219	2013/05/13
Pre-Amplifier	A&R	150A220	23067	N/A
Signal Generator	R&S	SMB100A	106404	2013/05/09
uniform field calibration	QTK	N/A	N/A	2013/05/20

Electrical fast transient/burst / SR3

Instrument	Manufacturer	Type No.	Serial No	Cal. Date
TRANSIENT TEST SYSTEM	EMC PARTNER	TRA2000IN6	1138	2013/03/22

Surge / SR3

Instrument	Manufacturer	Type No.	Serial No	Cal. Date
TRANSIENT TEST SYSTEM	EMC PARTNER	TRA2000IN6	1138	2013/03/22

Conducted susceptibility / SR6

Instrument	Manufacturer	Type No.	Serial No	Cal. Date
Schaffner NSG 2070 RF-Generator	Schaffner	N/A	N/A	2013/05/16

Power frequency magnetic field / SR3

Instrument	Manufacturer	Type No.	Serial No	Cal. Date
Induction Coil Interface	Schaffner	INA 2141	6002	N/A
Magnetic Loop Coil	Schaffner	INA 702	160	N/A

Voltage dips and interruption / SR3

Instrument	Manufacturer	Type No.	Serial No	Cal. Date
TRANSIENT TEST SYSTEM	EMC PARTNER	TRA2000IN6	1138	2013/03/22

2.3. Measurement Uncertainty

Conducted Emission

The measurement uncertainty is evaluated as ± 2.26 dB.

Radiated Emission

The measurement uncertainty is evaluated as ± 3.19 dB.

Harmonic Current Emission

The measurement uncertainty is evaluated as 5.1 (mA/A).

Voltage Fluctuation and Flicker

The measurement uncertainty is evaluated as 0.6 (mV/V).

Electrostatic Discharge

As what is concluded in the document from Note2 of clause 5.4.6.2 of ISO/IEC 17025, the requirements for measurement uncertainty in ESD testing are deemed to have been satisfied, and the testing is reported in accordance with the relevant ESD standards. The immunity test signal from the ESD system meet the required specifications in IEC 61000-4-2 through the calibration report with the calibrated uncertainty for the waveform of current and timing as being 2.5 % and 6%.

Radiated susceptibility

As what is concluded in the document from Note2 of clause 5.4.6.2 of ISO/IEC 17025, the requirements for measurement uncertainty in RS testing are deemed to have been satisfied, and the testing is reported in accordance with the relevant RS standards. The immunity test signal from the RS system meet the required specifications in IEC 61000-4-3 through the calibration for the uniform field strength and monitoring for the test level with the uncertainty evaluation report for the electrical field strength as being 3.57 dB.

Electrical fast transient/burst

As what is concluded in the document from Note2 of clause 5.4.6.2 of ISO/IEC 17025, the requirements for measurement uncertainty in EFT/Burst testing are deemed to have been satisfied, and the testing is reported in accordance with the relevant EFT/Burst standards. The immunity test signal from the EFT/Burst system meet the required specifications in IEC 61000-4-4 through the calibration report with the calibrated uncertainty for the waveform of voltage and timing as being 8.4 % and 4.7%.

Surge

As what is concluded in the document from Note2 of clause 5.4.6.2 of ISO/IEC 17025, the requirements for measurement uncertainty in Surge testing are deemed to have been satisfied, and the testing is reported in accordance with the relevant Surge standards. The immunity test signal from the Surge system meet the required specifications in IEC 61000-4-5 through the calibration report with the calibrated uncertainty for the waveform of voltage and timing as being 4.1 % and 3.9%.

Conducted susceptibility

As what is concluded in the document from Note2 of clause 5.4.6.2 of ISO/IEC 17025, the requirements for measurement uncertainty in CS testing are deemed to have been satisfied, and the testing is reported in accordance with the relevant CS standards. The immunity test signal from the CS system meet the required specifications in IEC 61000-4-6 through the calibration for unmodulated signal and monitoring for the test level with the uncertainty evaluation report for the injected modulated signal level through CDN and EM Clamp/Direct Injection as being 2.0 dB and 2.61 dB.

Power frequency magnetic field

As what is concluded in the document from Note2 of clause 5.4.6.2 of ISO/IEC 17025, the requirements for measurement uncertainty in PFM testing are deemed to have been satisfied, and the testing is reported in accordance with the relevant PFM standards. The immunity test signal from the PFM system meet the required specifications in IEC 61000-4-8 through the calibration report with the calibrated uncertainty for the Gauss Meter to verify the output level of magnetic field strength as being 1.0 %.

Voltage dips and interruption

As what is concluded in the document from Note2 of clause 5.4.6.2 of ISO/IEC 17025, the requirements for measurement uncertainty in DIP testing are deemed to have been satisfied, and the testing is reported in accordance with the relevant DIP standards. The immunity test signal from the DIP system meet the required specifications in IEC 61000-4-11 through the calibration report with the calibrated uncertainty for the waveform of voltage and timing as being 1.6 % and 2.8%.

2.4. Test Environment

Performed Item	Items	Required	Actual
Conducted Emission	Temperature (°C)	15-35	23
	Humidity (%RH)	25-75	59
	Barometric pressure (mbar)	860-1060	950-1000
Radiated Emission	Temperature (°C)	15-35	22.8
	Humidity (%RH)	25-75	61
	Barometric pressure (mbar)	860-1060	950-1000
Electrostatic Discharge	Temperature (°C)	15-35	23
	Humidity (%RH)	30-60	50
	Barometric pressure (mbar)	860-1060	950-1000
Radiated susceptibility	Temperature (°C)	15-35	23
	Humidity (%RH)	25-75	52
	Barometric pressure (mbar)	860-1060	950-1000
Electrical fast transient/burst	Temperature (°C)	15-35	23
	Humidity (%RH)	25-75	52
	Barometric pressure (mbar)	860-1060	950-1000
Surge	Temperature (°C)	15-35	23
	Humidity (%RH)	10-75	52
	Barometric pressure (mbar)	860-1060	950-1000
Conducted susceptibility	Temperature (°C)	15-35	23
	Humidity (%RH)	25-75	52
	Barometric pressure (mbar)	860-1060	950-1000
Power frequency magnetic field	Temperature (°C)	15-35	23
	Humidity (%RH)	25-75	52
	Barometric pressure (mbar)	860-1060	950-1000
Voltage dips and interruption	Temperature (°C)	15-35	23
	Humidity (%RH)	25-75	52
	Barometric pressure (mbar)	860-1060	950-1000

3. Conducted Emission (Main Terminals)

3.1. Test Specification

According to EMC Standard: EN 55022

3.2. Test Setup

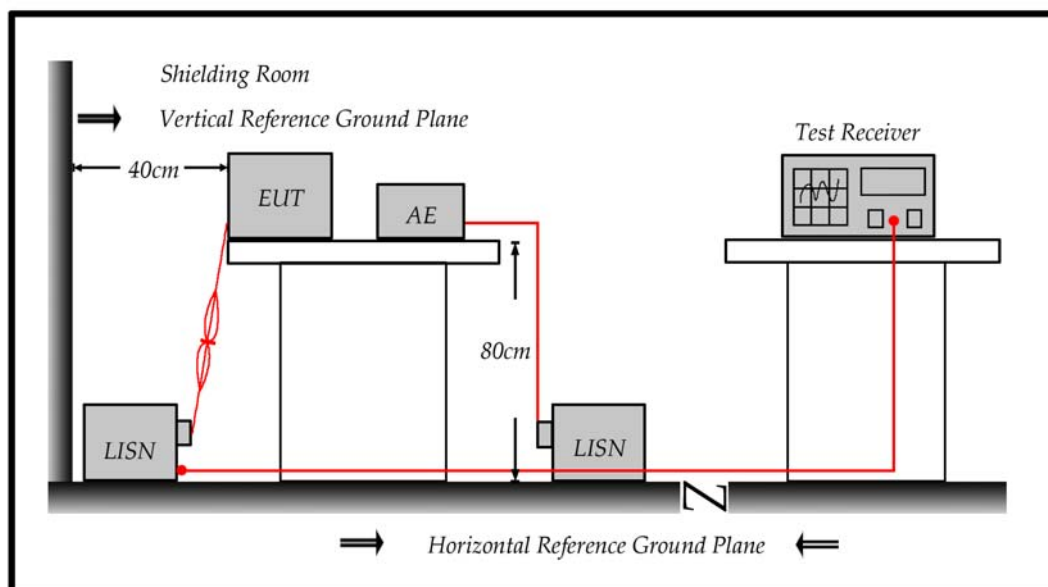

3.3. Limit

Limits		
Frequency (MHz)	QP (dBuV)	AV (dBuV)
0.15 - 0.50	66 - 56	56 - 46
0.50-5.0	56	46
5.0 - 30	60	50

Remarks: In the above table, the tighter limit applies at the band edges.

3.4. Test Procedure

The EUT and simulators are connected to the main power through a line impedance stabilization network (L.I.S.N.). This provides a 50 ohm /50uH coupling impedance for the measuring equipment. The peripheral devices are also connected to the main power through a LISN that provides a 50ohm/50uH coupling impedance with 50ohm termination.

(Please refers to the block diagram of the test setup and photographs.)

Both sides of A.C. line are checked for maximum conducted interference. In order to find the maximum emission, the relative positions of equipment and all of the interface cables must be changed on conducted measurement.

Conducted emissions were invested over the frequency range from 0.15MHz to 30MHz using a receiver bandwidth of 9kHz.

3.5. Deviation from Test Standard

No deviation.

3.6. Test Result

Site : SR8	Time : 2013/11/22 - 13:57
Limit : CISPR_B_00M_QP	Margin : 10
EUT : SATA Flash Drive	Probe : ENV216_L1 - Line1
Power : AC 230V/50Hz	Note : Mode 1

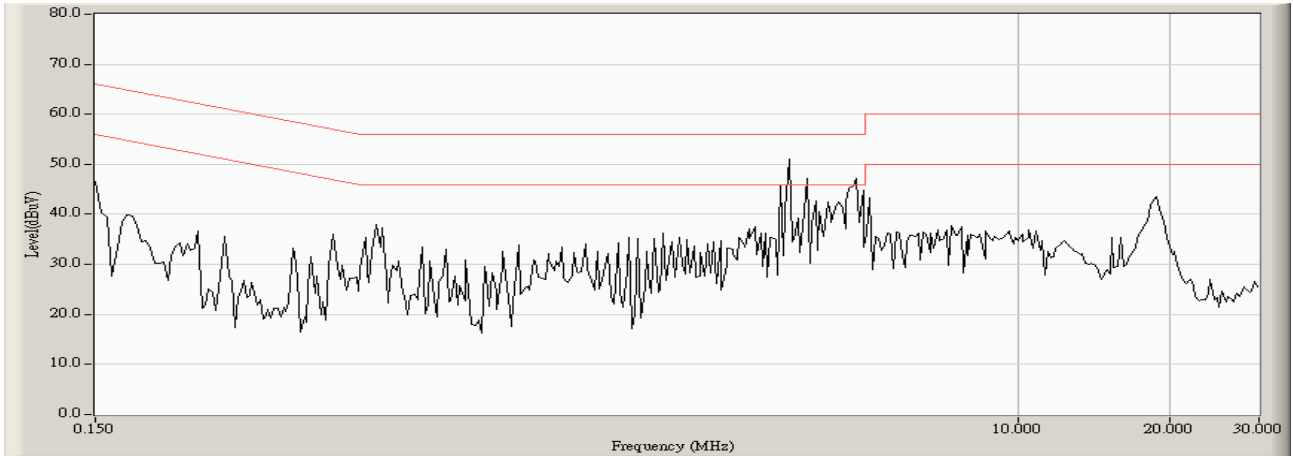

Site : SR8	Time : 2013/11/22 - 13:58
Limit : CISPR_B_00M_QP	Margin : 0
EUT : SATA Flash Drive	Probe : ENV216_L1 - Line1
Power : AC 230V/50Hz	Note : Mode 1

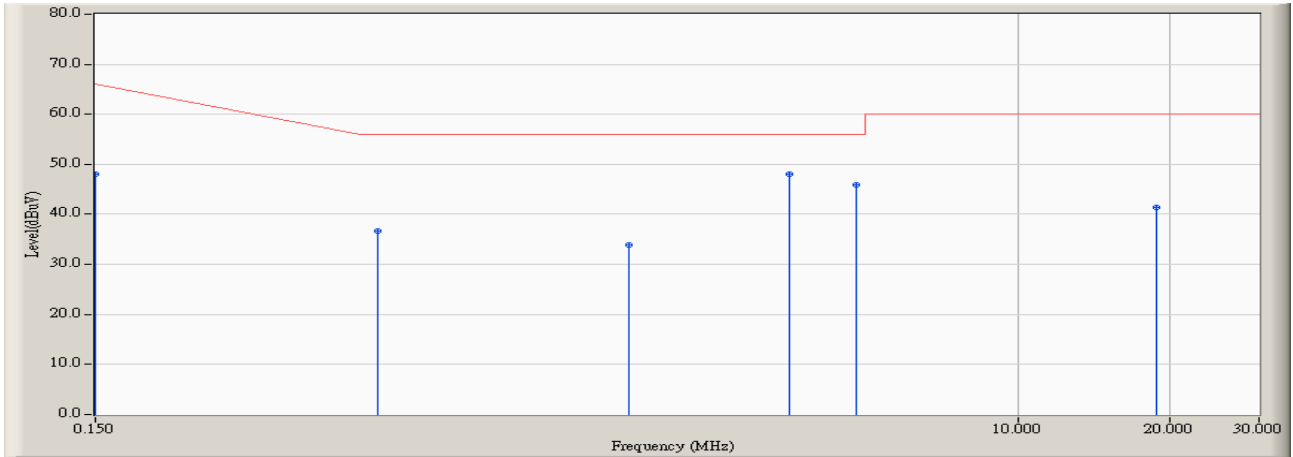

		Frequency (MHz)	Correct Factor (dB)	Reading Level (dBuV)	Measure Level (dBuV)	Margin (dB)	Limit (dBuV)	Detector Type
1		0.150	9.696	38.290	47.986	-18.014	66.000	QUASIPeAK
2		0.541	9.714	26.910	36.624	-19.376	56.000	QUASIPeAK
3		1.697	9.777	24.200	33.977	-22.023	56.000	QUASIPeAK
4	*	3.545	9.820	38.140	47.960	-8.040	56.000	QUASIPeAK
5		4.798	9.830	36.090	45.920	-10.080	56.000	QUASIPeAK
6		18.755	9.910	31.520	41.430	-18.570	60.000	QUASIPeAK

Note:

1. All Reading Levels are Quasi-Peak and average value.
2. " * ", means this data is the worst emission level.
3. Measurement Level = Reading Level + Correct Factor

Site : SR8	Time : 2013/11/22 - 13:58
Limit : CISPR_B_00M_AV	Margin : 0
EUT : SATA Flash Drive	Probe : ENV216_L1 - Line1
Power : AC 230V/50Hz	Note : Mode 1

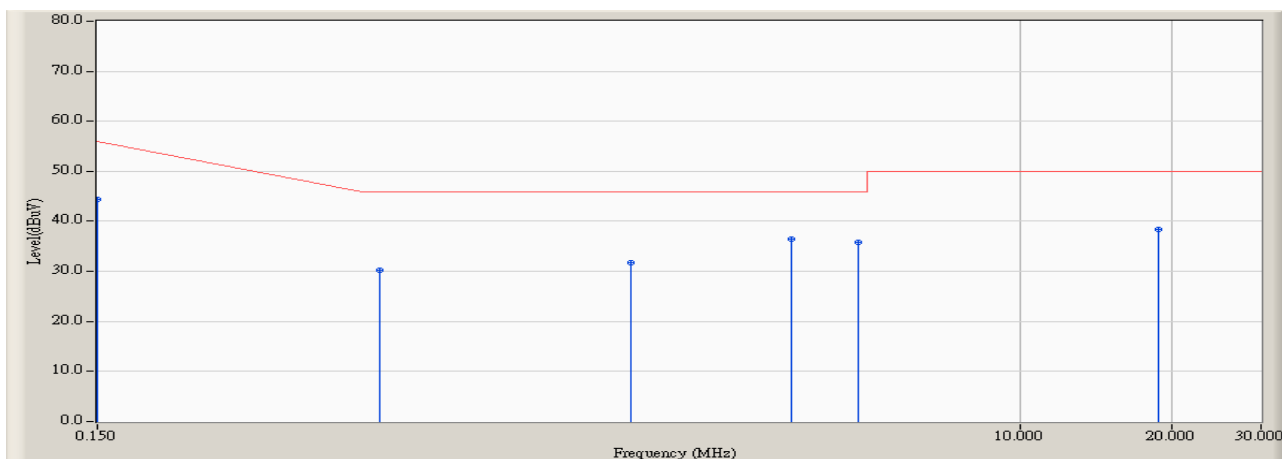

		Frequency (MHz)	Correct Factor (dB)	Reading Level (dBuV)	Measure Level (dBuV)	Margin (dB)	Limit (dBuV)	Detector Type
1		0.150	9.696	34.670	44.366	-11.634	56.000	AVERAGE
2		0.541	9.714	20.470	30.184	-15.816	46.000	AVERAGE
3		1.697	9.777	21.980	31.757	-14.243	46.000	AVERAGE
4	*	3.545	9.820	26.700	36.520	-9.480	46.000	AVERAGE
5		4.798	9.830	26.060	35.890	-10.110	46.000	AVERAGE
6		18.755	9.910	28.380	38.290	-11.710	50.000	AVERAGE

Note:

1. All Reading Levels are Quasi-Peak and average value.
2. " * ", means this data is the worst emission level.
3. Measurement Level = Reading Level + Correct Factor

Site : SR8	Time : 2013/11/22 - 13:56
Limit : CISPR_B_00M_QP	Margin : 10
EUT : SATA Flash Drive	Probe : ENV216_N - Line2
Power : AC 230V/50Hz	Note : Mode 1

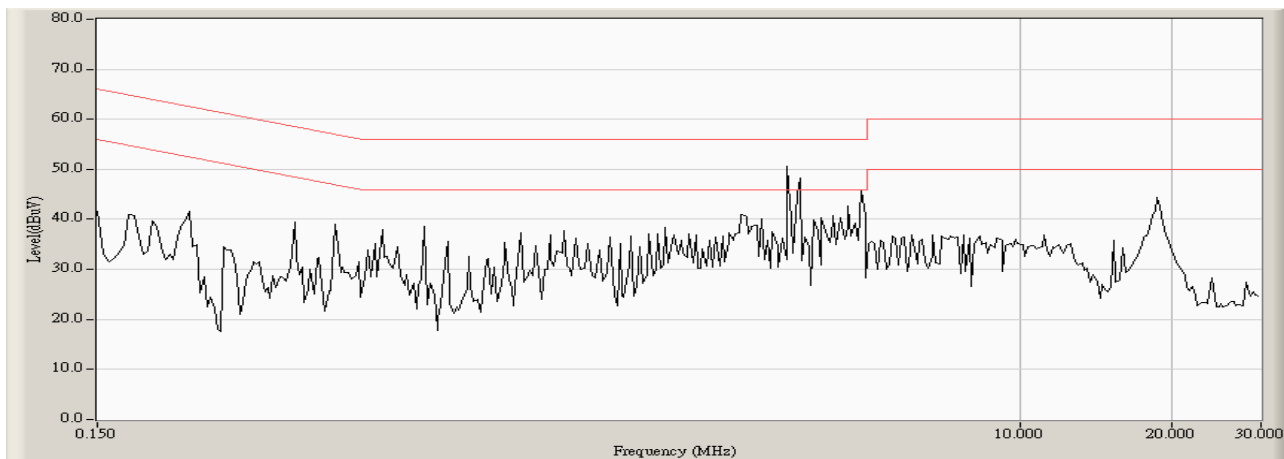

Site : SR8	Time : 2013/11/22 - 13:56
Limit : CISPR_B_00M_QP	Margin : 0
EUT : SATA Flash Drive	Probe : ENV216_N - Line2
Power : AC 230V/50Hz	Note : Mode 1

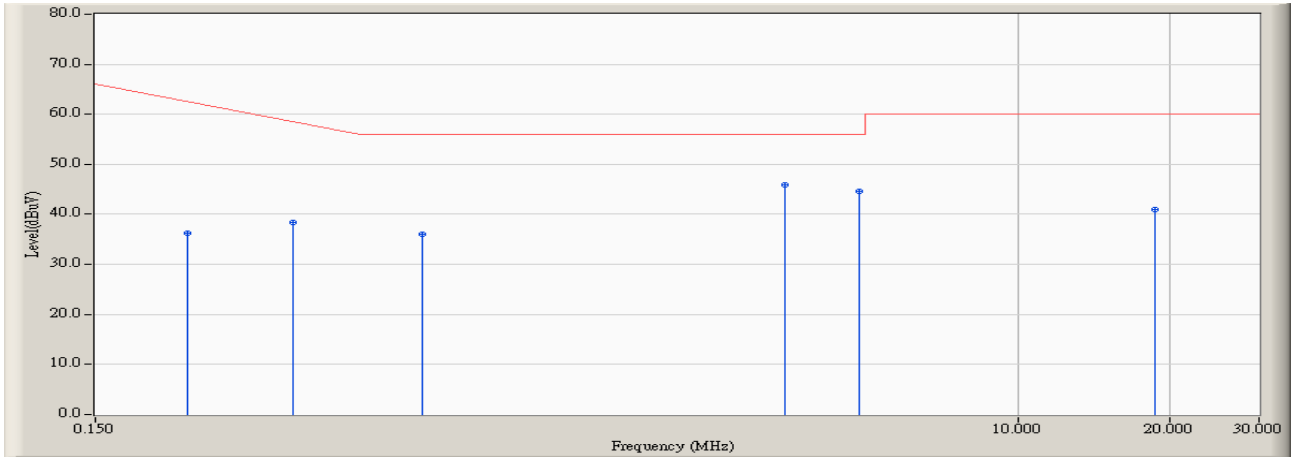

		Frequency (MHz)	Correct Factor (dB)	Reading Level (dBuV)	Measure Level (dBuV)	Margin (dB)	Limit (dBuV)	Detector Type
1		0.228	9.680	26.470	36.150	-27.621	63.771	QUASPEAK
2		0.369	9.686	28.750	38.436	-21.307	59.743	QUASPEAK
3		0.666	9.700	26.420	36.120	-19.880	56.000	QUASPEAK
4	*	3.470	9.800	36.110	45.910	-10.090	56.000	QUASPEAK
5		4.873	9.820	34.810	44.630	-11.370	56.000	QUASPEAK
6		18.744	10.000	30.890	40.890	-19.110	60.000	QUASPEAK

Note:

1. All Reading Levels are Quasi-Peak and average value.
2. " * ", means this data is the worst emission level.
3. Measurement Level = Reading Level + Correct Factor

Site : SR8	Time : 2013/11/22 - 13:56
Limit : CISPR_B_00M_AV	Margin : 0
EUT : SATA Flash Drive	Probe : ENV216_N - Line2
Power : AC 230V/50Hz	Note : Mode 1

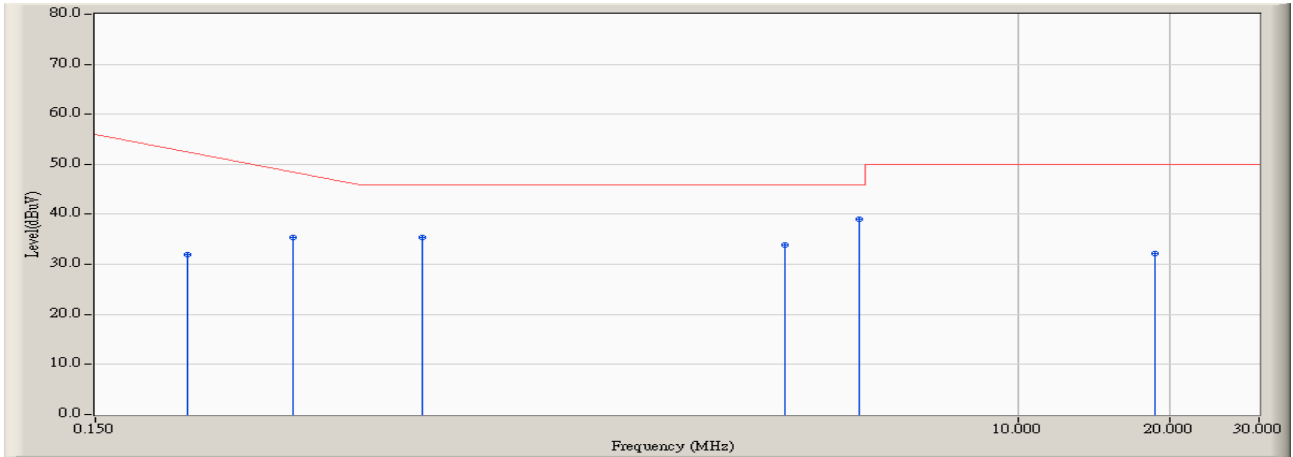

	Frequency (MHz)	Correct Factor (dB)	Reading Level (dBuV)	Measure Level (dBuV)	Margin (dB)	Limit (dBuV)	Detector Type
1	0.228	9.680	22.230	31.910	-21.861	53.771	AVERAGE
2	0.369	9.686	25.690	35.376	-14.367	49.743	AVERAGE
3	0.666	9.700	25.780	35.480	-10.520	46.000	AVERAGE
4	3.470	9.800	24.130	33.930	-12.070	46.000	AVERAGE
5	* 4.873	9.820	29.320	39.140	-6.860	46.000	AVERAGE
6	18.744	10.000	22.230	32.230	-17.770	50.000	AVERAGE

Note:

1. All Reading Levels are Quasi-Peak and average value.
2. " * ", means this data is the worst emission level.
3. Measurement Level = Reading Level + Correct Factor

3.7. Test Photograph

Test Mode : Mode 1: Normal Operation

Description : Front View of Conducted Test



Test Mode : Mode 1: Normal Operation

Description : Back View of Conducted Test



4. Radiated Emission

4.1. Test Specification

According to EMC Standard : EN 55022

4.2. Test Setup

Under 1GHz Test Setup:

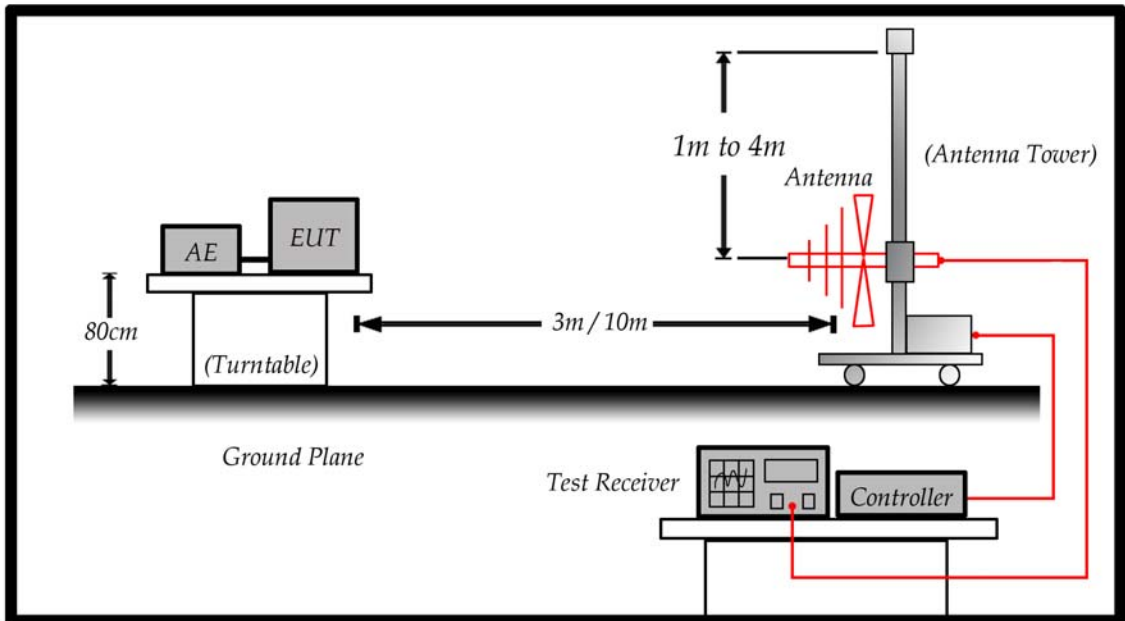

Above 1GHz Test Setup:

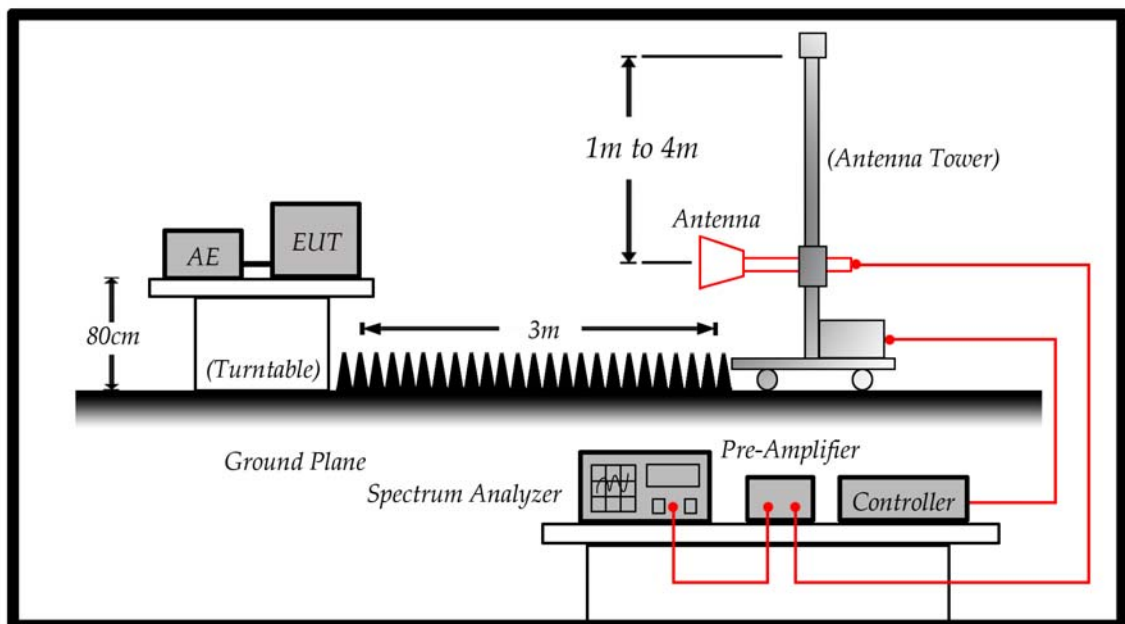

4.3. Limit

Limits		
Frequency (MHz)	Distance (m)	dBuV/m
30 – 230	10	30
230 – 1000	10	37

Limits			
Frequency (GHz)	Distance (m)	Peak (dBuV/m)	Average (dBuV/m)
1 – 3	3	70	50
3 – 6	3	74	54

Remark:

1. The tighter limit shall apply at the edge between two frequency bands.
2. Distance refers to the distance in meters between the measuring instrument antenna and the closed point of any part of the device or system.

Highest frequency generated or used in the device or on which the device operates or tunes (MHz)	Upper frequency of measurement range (MHz)
Below 108	1000
108 – 500	2000
500 – 1000	5000
Above 1000	5 th harmonic of the highest frequency or 6 GHz, whichever is lower

4.4. Test Procedure

The EUT and its simulators are placed on a turn table which is 0.8 meter above ground. The turn table can rotate 360 degrees to determine the position of the maximum emission level. The EUT was positioned such that the distance from antenna to the EUT was 3/10 meters. The antenna can move up and down between 1 meter and 4 meters to find out the maximum emission level.

Both horizontal and vertical polarization of the antenna are set on measurement. In order to find the maximum emission, all of the interface cables must be manipulated on radiated measurement.

Radiated emissions were investigated over the frequency range from 30MHz to 1GHz using a receiver bandwidth of 120kHz and above 1GHz using a receiver bandwidth of 1MHz.

30MHz to 1GHz Radiated was performed at an antenna to EUT distance of 10 meters.

Above 1GHz Radiated was performed at an antenna to EUT distance of 3 meters.

It is placed with absorb on the ground between EUT and Antenna.

4.5. Deviation from Test Standard

No deviation.

4.6. Test Result

Site : Site7	Time : 2013/11/22 - 15:46
Limit : CISPR_B_10M_QP	Margin : 6
EUT : SATA Flash Drive	Probe : Site7_CBL6112_10M_1307 - HORIZONTAL
Power : AC 230V/50Hz	Note : Mode 1

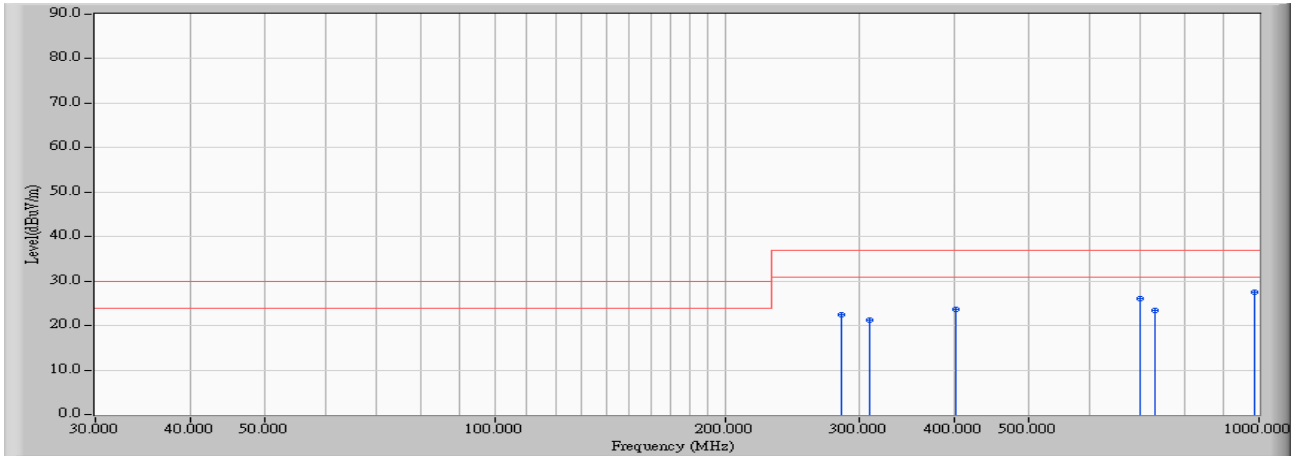

		Frequency (MHz)	Correct Factor (dB)	Reading Level (dBuV)	Measure Level (dBuV/m)	Margin (dB)	Limit (dBuV/m)	Detector Type
1		283.600	-15.257	37.800	22.543	-14.457	37.000	QUASIPeAK
2		309.500	-14.655	35.850	21.196	-15.804	37.000	QUASIPeAK
3		401.800	-11.438	35.200	23.762	-13.238	37.000	QUASIPeAK
4		698.400	-6.791	32.800	26.009	-10.991	37.000	QUASIPeAK
5		730.800	-5.696	29.100	23.404	-13.596	37.000	QUASIPeAK
6	*	987.360	-2.000	29.600	27.600	-9.400	37.000	QUASIPeAK

Note:

1. All Readings below 1GHz are Quasi-Peak, above are performed with peak and/or average measurements as necessary.
2. " * ", means this data is the worst emission level.
3. Measurement Level = Reading Level + Correct Factor

Site : Site7	Time : 2013/11/22 - 16:03
Limit : CISPR_B_10M_QP	Margin : 6
EUT : SATA Flash Drive	Probe : Site7_CBL6112_10M_1307 - VERTICAL
Power : AC 230V/50Hz	Note : Mode 1

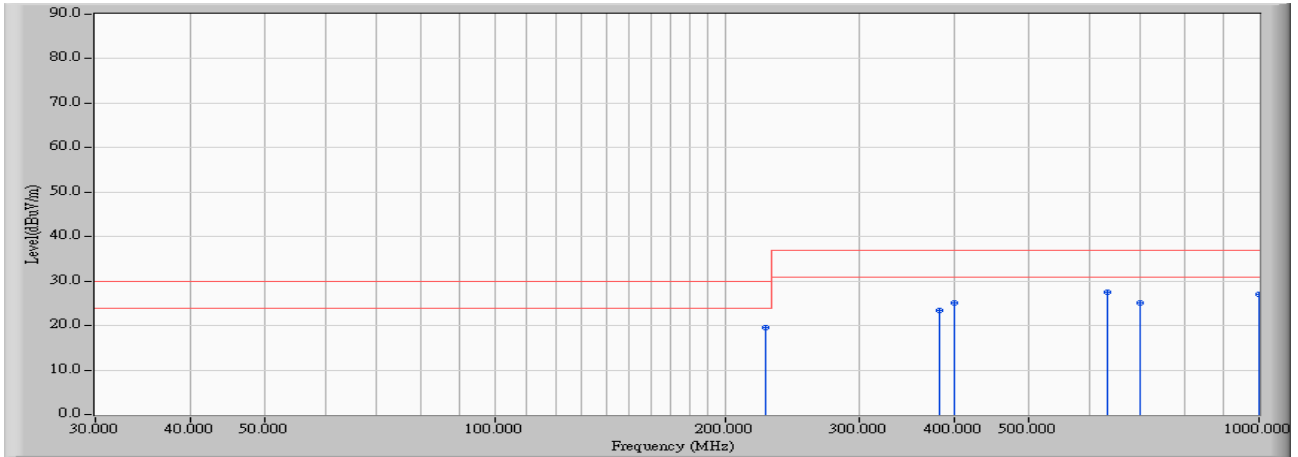

		Frequency (MHz)	Correct Factor (dB)	Reading Level (dBuV)	Measure Level (dBuV/m)	Margin (dB)	Limit (dBuV/m)	Detector Type
1		226.000	-19.122	38.600	19.478	-10.522	30.000	QUASIPeAK
2		381.050	-12.124	35.560	23.436	-13.564	37.000	QUASIPeAK
3		400.000	-11.497	36.500	25.003	-11.997	37.000	QUASIPeAK
4	*	632.000	-6.594	34.000	27.406	-9.594	37.000	QUASIPeAK
5		699.600	-6.797	32.000	25.203	-11.797	37.000	QUASIPeAK
6		999.510	-1.810	28.950	27.140	-9.860	37.000	QUASIPeAK

Note:

1. All Readings below 1GHz are Quasi-Peak, above are performed with peak and/or average measurements as necessary.
2. " * ", means this data is the worst emission level.
3. Measurement Level = Reading Level + Correct Factor

Site: CB7	Time: 2013/11/22 - 18:59
Limit: EN55022_B_(Above_1G)	Margin: 0
Probe: CB7_Horn_9120D_1302	Polarity: Horizontal
EUT : SATA Flash Drive	Power : AC 230V/50Hz
Note : Mode 1	

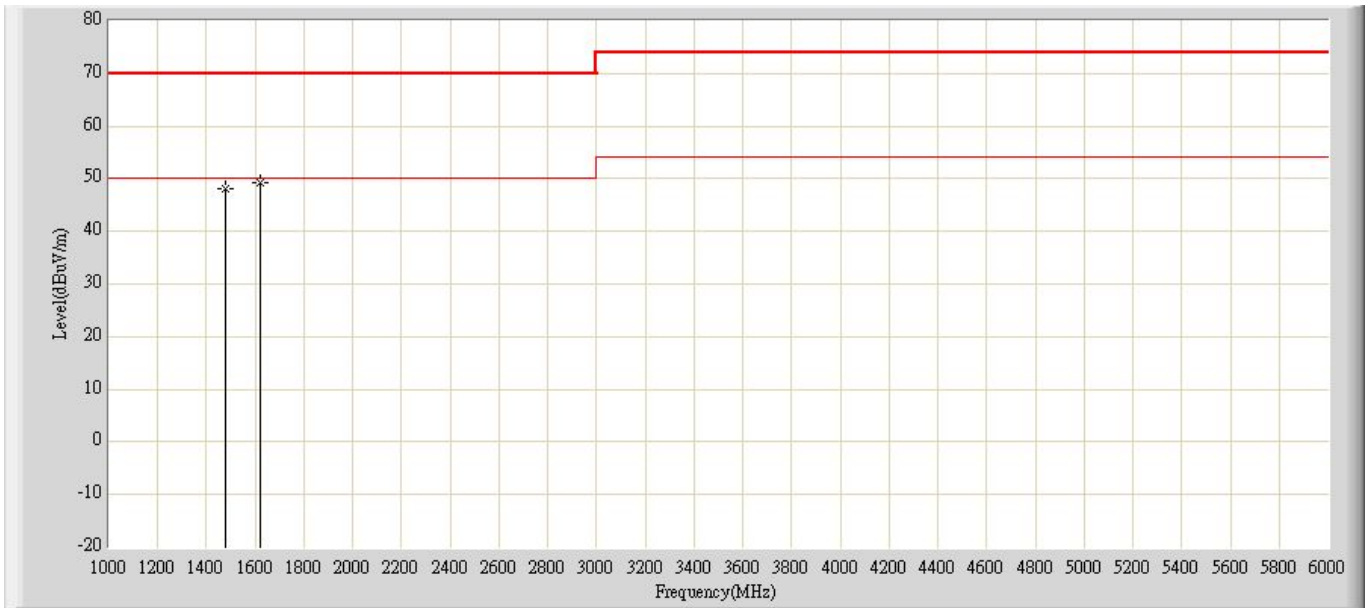

No	Flag	Mark	Frequency (MHz)	Measure Level (dBuV/m)	Reading Level (dBuV)	Over Limit (dB)	Limit (dBuV/m)	Factor	Type
1			1480.000	48.015	52.450	-21.985	70.000	-4.435	PK
2		*	1620.000	49.133	53.140	-20.867	70.000	-4.008	PK

Note:

1. All Readings below 1GHz are Quasi-Peak, above are performed with peak and/or average measurements as necessary.
2. " * ", means this data is the worst emission level.
3. Measurement Level = Reading Level + Factor(Probe+Cable-Amp).

Site: CB7	Time: 2013/11/22 - 19:03
Limit: EN55022_B_(Above_1G)	Margin: 0
Probe: CB7_Horn_9120D_1302	Polarity: Vertical
EUT : SATA Flash Drive	Power : AC 230V/50Hz
Note : Mode 1	

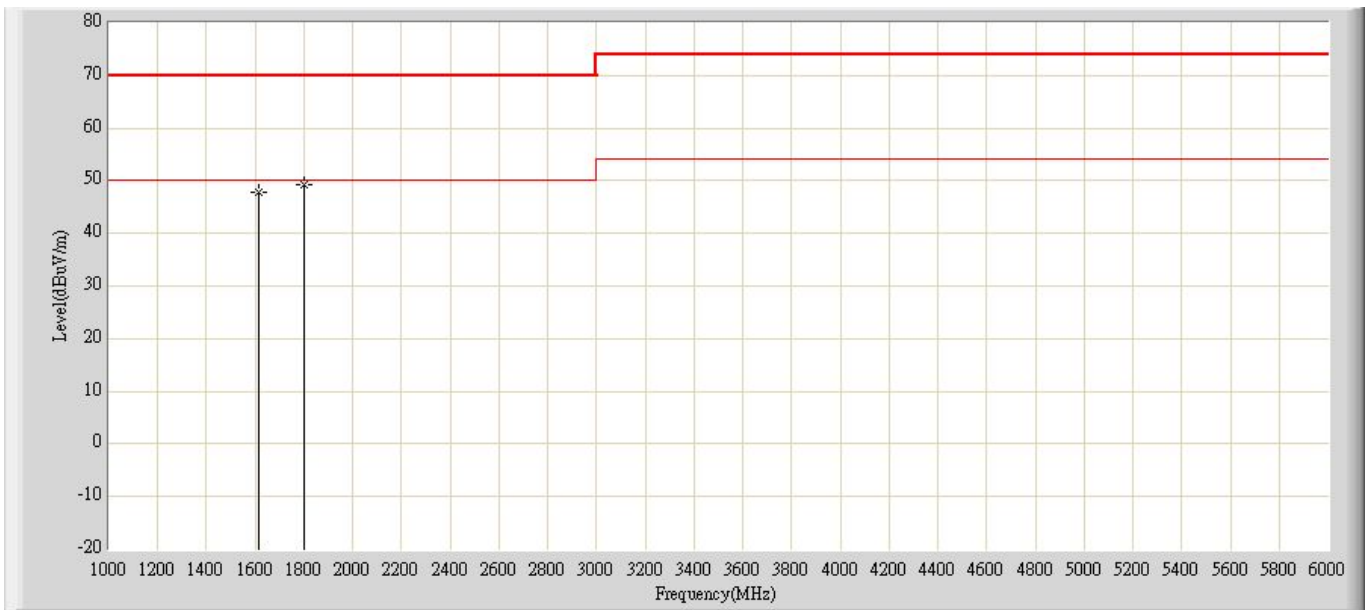

No	Flag	Mark	Frequency (MHz)	Measure Level (dBuV/m)	Reading Level (dBuV)	Over Limit (dB)	Limit (dBuV/m)	Factor	Type
1			1615.000	47.772	51.740	-22.228	70.000	-3.968	PK
2		*	1800.000	49.285	52.780	-20.715	70.000	-3.495	PK

Note:

1. All Readings below 1GHz are Quasi-Peak, above are performed with peak and/or average measurements as necessary.
2. " * ", means this data is the worst emission level.
3. Measurement Level = Reading Level + Factor(Probe+Cable-Amp).

4.7. Test Photograph

Test Mode : Mode 1: Normal Operation

Description : Front View of Radiated Test



Test Mode : Mode 1: Normal Operation

Description : Back View of Radiated Test



Test Mode : Mode 1: Normal Operation

Description : Front View of High Frequency Radiated Test



5. Harmonic Current Emission

5.1. Test Specification

According to EMC Standard : EN 61000-3-2

5.2. Test Setup

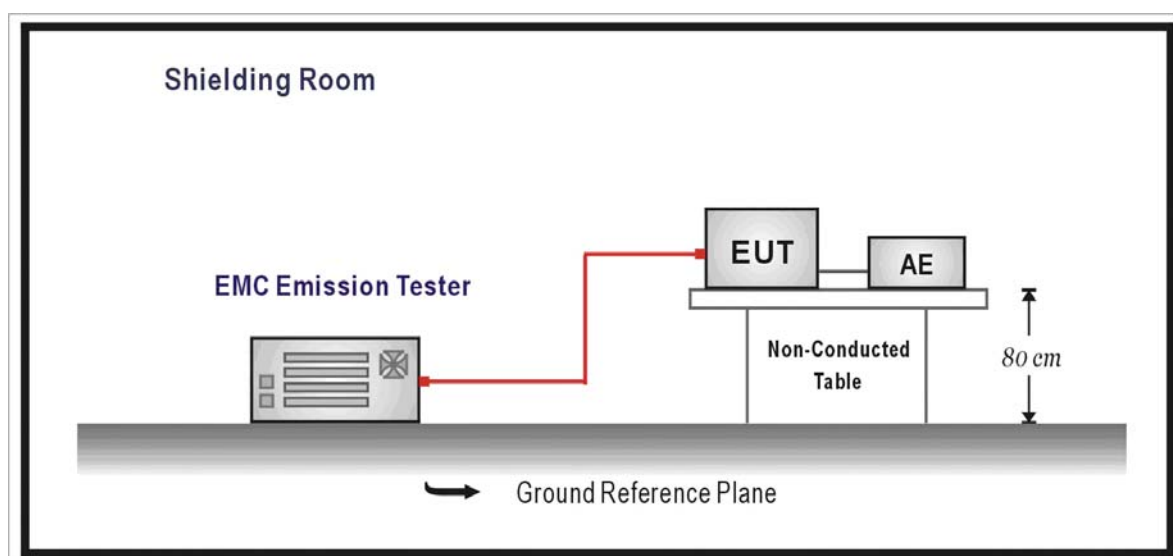

5.3. Limit

(a) Limits of Class A Harmonics Currents

Harmonics Order n	Maximum Permissible harmonic current A	Harmonics Order n	Maximum Permissible harmonic current A
Odd harmonics		Even harmonics	
3	2.30	2	1.08
5	1.14	4	0.43
7	0.77	6	0.30
9	0.40	8 ≤ n ≤ 40	0.23 * 8/n
11	0.33		
13	0.21		
15 ≤ n ≤ 39	0.15 * 15/n		

(b) Limits of Class B Harmonics Currents

For Class B equipment, the harmonic of the input current shall not exceed the maximum permissible values given in table that is the limit of Class A multiplied by a factor of 1.5.

(c) Limits of Class C Harmonics Currents

Harmonics Order n	Maximum Permissible harmonic current Expressed as a percentage of the input current at the fundamental frequency %
2	2
3	$30 \cdot \lambda^*$
5	10
7	7
9	5
$11 \leq n \leq 39$ (odd harmonics only)	3

* λ is the circuit power factor

(d) Limits of Class D Harmonics Currents

Harmonics Order n	Maximum Permissible harmonic current per watt mA/W	Maximum Permissible harmonic current A
3	3.4	2.30
5	1.9	1.14
7	1.0	0.77
9	0.5	0.40
11	0.35	0.33
$11 \leq n \leq 39$ (odd harmonics only)	$3.85/n$	See limit of Class A

5.4. Test Procedure

The EUT is supplied in series with power analyzer from a power source having the same normal voltage and frequency as the rated supply voltage and the equipment under test. And the rated voltage at the supply voltage of EUT of 0.94 times and 1.06 times shall be performed.

5.5. Deviation from Test Standard

No deviation.

5.6. Test Result

Product	SATA Flash Drive		
Test Item	Power Harmonics		
Test Mode	Mode 1: Normal Operation		
Date of Test	2013/11/26	Test Site	No.3 Shielded Room

Test Result: Pass Source qualification: Normal

Current & voltage waveforms

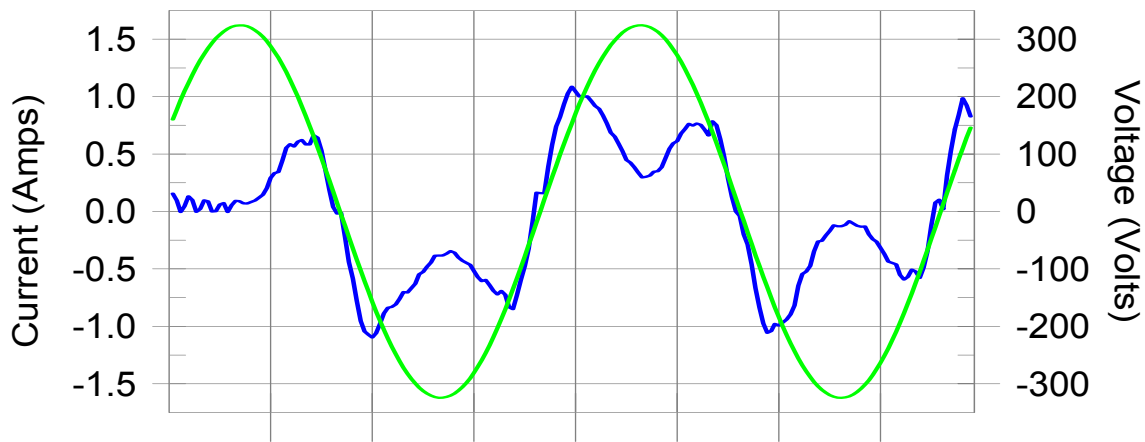

Harmonics and Class A limit line

European Limits

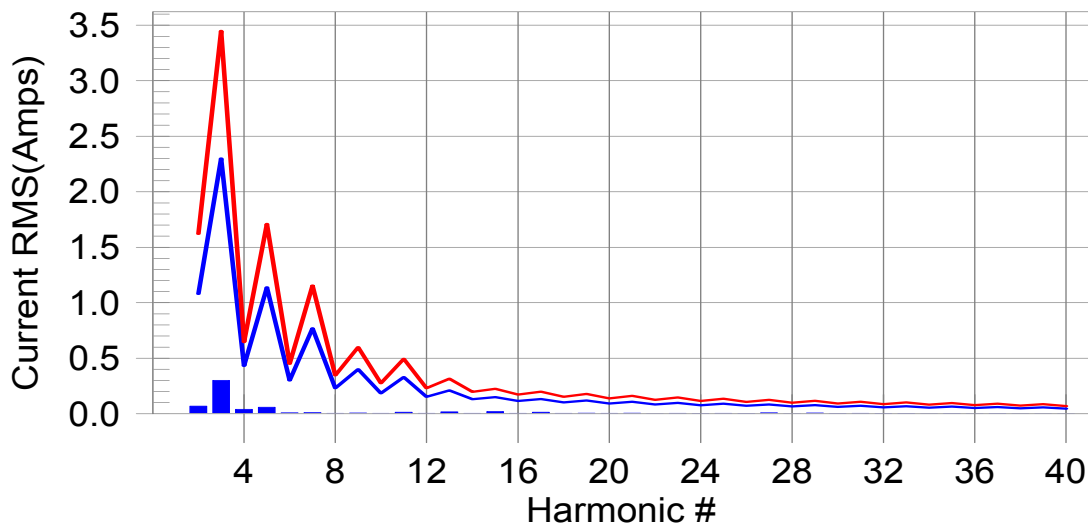

Test result: Pass Worst harmonic was #3 with 8.70% of the limit.

Test Result: Pass Source qualification: Normal
 THC(A): 0.21 I-THD(%): 90.57 POHC(A): 0.000 POHC Limit(A): 0.320
 Highest parameter values during test:

V_RMS (Volts):	229.52	Frequency(Hz):	50.00
I_Peak (Amps):	1.212	I_RMS (Amps):	0.506
I_Fund (Amps):	0.317	Crest Factor:	3.118
Power (Watts):	68.4	Power Factor:	0.644

Harm#	Harms(avg)	100%Limit	%of Limit	Harms(max)	150%Limit	%of Limit	Status
2	0.050	1.080	4.7	0.069	1.620	4.26	Pass
3	0.196	2.300	8.5	0.300	3.450	8.70	Pass
4	0.031	0.430	7.1	0.040	0.645	6.20	Pass
5	0.036	1.140	3.2	0.058	1.710	3.41	Pass
6	0.005	0.300	1.7	0.009	0.450	1.99	Pass
7	0.006	0.770	0.8	0.010	1.155	0.89	Pass
8	0.003	0.230	0.0	0.005	0.345	1.38	Pass
9	0.004	0.400	0.8	0.006	0.600	1.05	Pass
10	0.002	0.184	0.0	0.003	0.276	1.18	Pass
11	0.009	0.330	2.7	0.014	0.495	2.74	Pass
12	0.003	0.153	0.0	0.004	0.230	1.68	Pass
13	0.013	0.210	6.0	0.017	0.315	5.54	Pass
14	0.002	0.131	0.0	0.003	0.197	1.63	Pass
15	0.011	0.150	7.4	0.019	0.225	8.32	Pass
16	0.003	0.115	0.0	0.004	0.173	2.45	Pass
17	0.007	0.132	5.3	0.014	0.199	7.25	Pass
18	0.003	0.102	0.0	0.004	0.153	2.86	Pass
19	0.004	0.118	3.6	0.006	0.178	3.23	Pass
20	0.002	0.092	0.0	0.004	0.138	2.70	Pass
21	0.003	0.107	3.4	0.006	0.161	3.64	Pass
22	0.001	0.084	0.0	0.002	0.125	1.43	Pass
23	0.001	0.098	0.0	0.005	0.147	3.29	Pass
24	0.001	0.077	0.0	0.003	0.115	2.25	Pass
25	0.002	0.090	0.0	0.003	0.135	2.49	Pass
26	0.001	0.071	0.0	0.003	0.106	2.91	Pass
27	0.004	0.083	5.4	0.008	0.125	6.06	Pass
28	0.001	0.066	0.0	0.002	0.099	1.97	Pass
29	0.004	0.078	5.5	0.007	0.116	5.65	Pass
30	0.002	0.061	0.0	0.002	0.092	2.41	Pass
31	0.002	0.073	0.0	0.004	0.109	4.08	Pass
32	0.001	0.058	0.0	0.002	0.086	2.46	Pass
33	0.001	0.068	0.0	0.003	0.102	2.62	Pass
34	0.001	0.054	0.0	0.002	0.081	1.98	Pass
35	0.001	0.064	0.0	0.003	0.096	2.89	Pass
36	0.001	0.051	0.0	0.001	0.077	1.31	Pass
37	0.001	0.061	0.0	0.002	0.091	2.37	Pass
38	0.001	0.048	0.0	0.001	0.073	1.60	Pass
39	0.001	0.058	0.0	0.002	0.087	1.77	Pass
40	0.001	0.046	0.0	0.001	0.069	1.89	Pass

1.Dynamic limits were applied for this test. The highest harmonics values in the above table may not occur at the same window as the maximum harmonics/limit ratio.

2:According to EN61000-3-2 paragraph 7 the note 1 and 2 are valid for all applications having an active input power >75W. Others the result should be pass.

5.7. Test Photograph

Test Mode : Mode 1: Normal Operation

Description : Power Harmonics Test Setup



6. Voltage Fluctuation and Flicker

6.1. Test Specification

According to EMC Standard : EN 61000-3-3

6.2. Test Setup

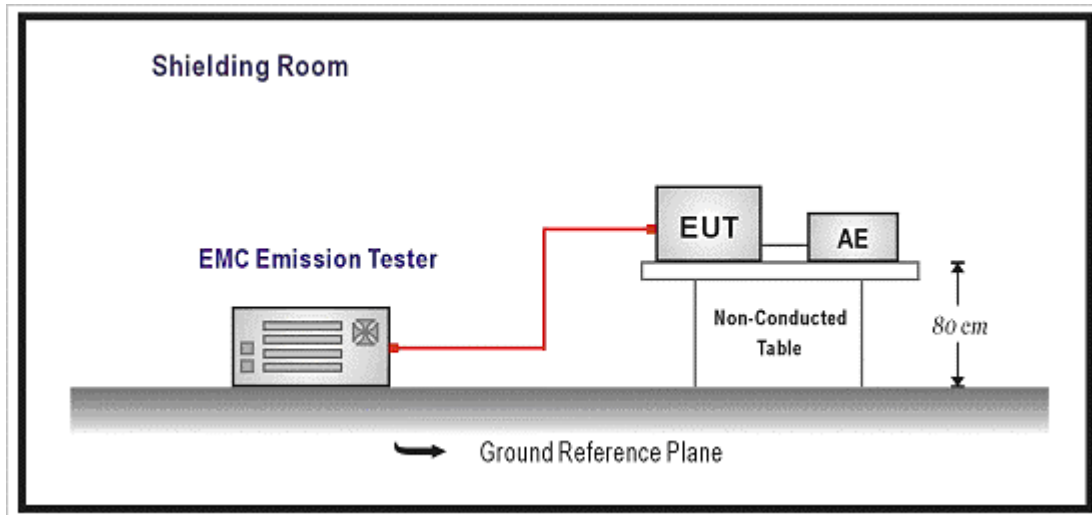

6.3. Limit

The following limits apply:

- the value of P_{st} shall not be greater than 1.0;
- the value of P_{1t} shall not be greater than 0.65;
- the value of $d(t)$ during a voltage change shall not exceed 3.3 % for more than 500 ms;
- the relative steady-state voltage change, d_c , shall not exceed 3.3 %;
- the maximum relative voltage change, d_{max} , shall not exceed;
 - a) 4 % without additional conditions;
 - b) 6 % for equipment which is:
 - switched manually, or
 - switched automatically more frequently than twice per day, and also has either a delayed restart (the delay being not less than a few tens of seconds), or manual restart, after a power supply interruption.

NOTE The cycling frequency will be further limited by the P_{st} and P_{1t} limit.

For example: a d_{max} of 6% producing a rectangular voltage change characteristic twice per hour will give a P_{1t} of about 0.65.

- c) 7 % for equipment which is:
- attended whilst in use (for example: hair dryers, vacuum cleaners, kitchen equipment such as mixers, garden equipment such as lawn mowers, portable tools such as electric drills), or
 - switched on automatically, or is intended to be switched on manually, no more than twice per day, and also has either a delayed restart (the delay being not less than a few tens of seconds) or manual restart, after a power supply interruption.

P_{st} and P_{1t} requirements shall not be applied to voltage changes caused by manual switching.

6.4. Test Procedure

The EUT is supplied in series with power analyzer from a power source having the same normal voltage and frequency as the rated supply voltage and the equipment under test. And the rated voltage at the supply voltage of EUT of 0.94 times and 1.06 times shall be performed.

6.5. Deviation from Test Standard

No deviation.

6.6. Test Result

Product	SATA Flash Drive		
Test Item	Voltage Fluctuation and Flicker		
Test Mode	Mode 1: Normal Operation		
Date of Test	2013/11/26	Test Site	No.3 Shielded Room

Test Result: Pass

Status: Test Completed

Pstj and limit line

European Limits

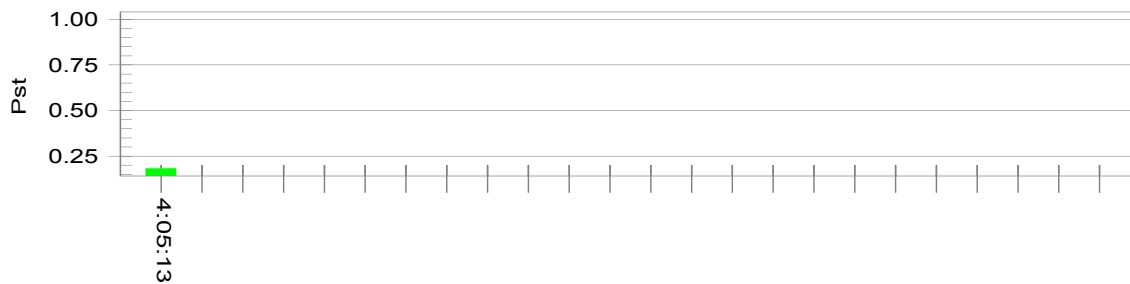

Plt and limit line

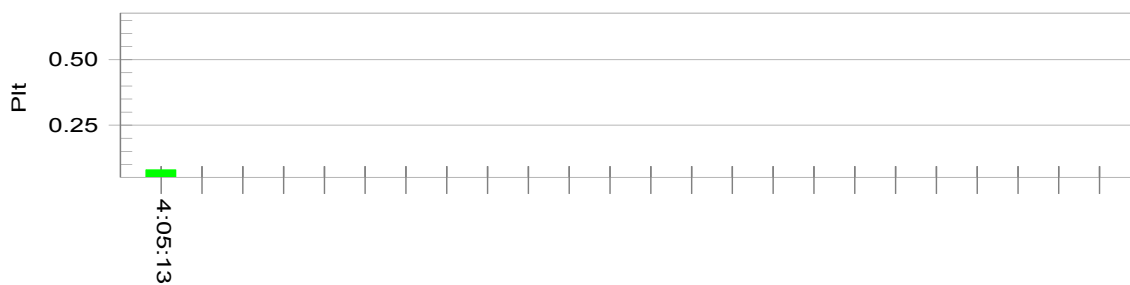

Parameter values recorded during the test:

Vrms at the end of test (Volt):	229.32			
Highest dt (%):	0.00	Test limit (%):	3.30	Pass
Time(mS) > dt:	0.0	Test limit (mS):	500.0	Pass
Highest dc (%):	0.00	Test limit (%):	3.30	Pass
Highest dmax (%):	0.00	Test limit (%):	4.00	Pass
Highest Pst (10 min. period):	0.182	Test limit:	1.000	Pass
Highest Plt (2 hr. period):	0.079	Test limit:	0.650	Pass

6.7. Test Photograph

Test Mode : Mode 1: Normal Operation

Description : Flicker Test Setup



7. Electrostatic Discharge

7.1. Test Specification

According to Standard: IEC 61000-4-2

7.2. Test Setup

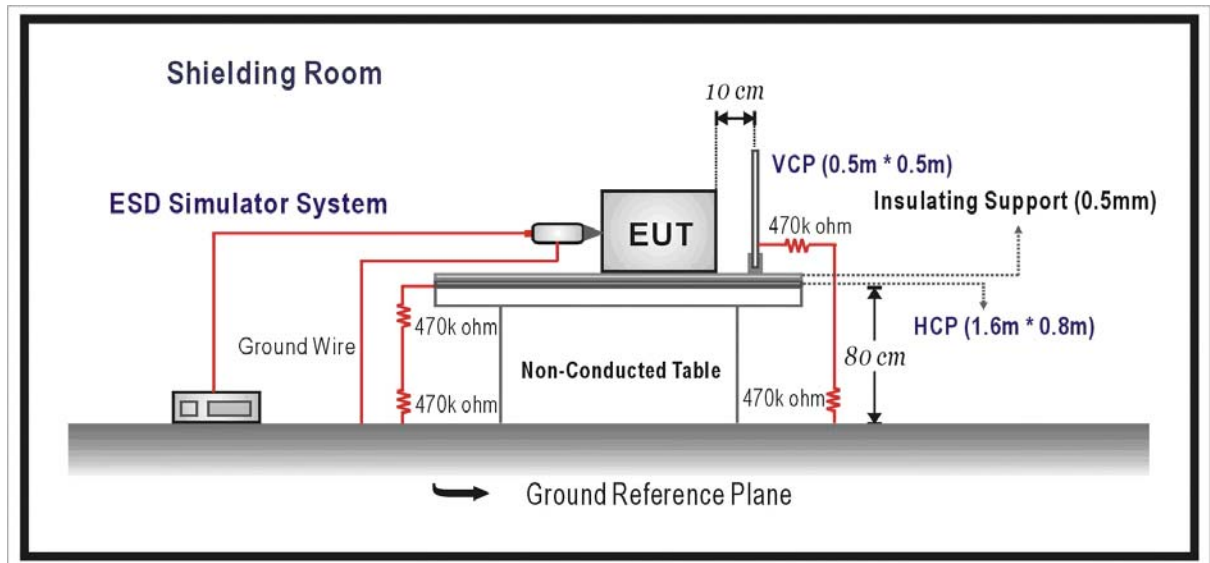

7.3. Limit

Item	Environmental Phenomena	Units	Test Specification	Performance Criteria
Enclosure Port				
	Electrostatic Discharge	kV(Charge Voltage)	±8 Air Discharge ±4 Contact Discharge	B

7.4. Test Procedure

Direct application of discharges to the EUT:

Contact discharge was applied only to conductive surfaces of the EUT.

Air discharges were applied only to non-conductive surfaces of the EUT.

During the test, it was performed with single discharges. For the single discharge time between successive single discharges will be keep longer 1 second. It was at least ten single discharges with positive and negative at the same selected point.

The selected point, which was performed with electrostatic discharge, was marked on the red label of the EUT.

Indirect application of discharges to the EUT:

Vertical Coupling Plane (VCP):

The coupling plane, of dimensions 0.5m x 0.5m, is placed parallel to, and positioned at a distance 0.1m from, the EUT, with the Discharge Electrode touching the coupling plane.

The four faces of the EUT will be performed with electrostatic discharge. It was at least ten single discharges with positive and negative at the same selected point.

Horizontal Coupling Plane (HCP):

The coupling plane is placed under to the EUT. The generator shall be positioned vertically at a distance of 0.1m from the EUT, with the Discharge Electrode touching the coupling plane.

The four faces of the EUT will be performed with electrostatic discharge. It was at least ten single discharges with positive and negative at the same selected point.

7.5. Deviation from Test Standard

No deviation.

7.6. Test Result

Product	SATA Flash Drive		
Test Item	Electrostatic Discharge		
Test Mode	Mode 1: Normal Operation		
Date of Test	2013/11/26	Test Site	No.6 Shielded Room

Item	Amount of Discharge	Voltage	Required Criteria	Complied To Criteria (A,B,C)	Results
Air Discharge	10	+8kV	B	A	Pass
	10	-8kV	B	A	Pass
Contact Discharge	25	+4kV	B	A	Pass
	25	-4kV	B	A	Pass
Indirect Discharge (HCP)	25	+4kV	B	A	Pass
	25	-4kV	B	A	Pass
Indirect Discharge (VCP)	25	+4kV	B	A	Pass
	25	-4kV	B	A	Pass

Note:

The testing performed is from lowest level up to the highest level as required by standard, but only highest level is shown on the report.

NR: No Requirement

- Meet criteria A: Operate as intended during and after the test
- Meet criteria B: Operate as intended after the test
- Meet criteria C: Loss/Error of function
- Additional Information
 - EUT stopped operation and could / could not be reset by operator at ____ kV.
 - No false alarms or other malfunctions were observed during or after the test.

Remark:

The Contact discharges were applied at least total 200 discharges at a minimum of four test points.

7.7. Test Photograph

Test Mode : Mode 1: Normal Operation

Description : ESD Test Setup



8. Radiated Susceptibility

8.1. Test Specification

According to Standard: IEC 61000-4-3

8.2. Test Setup

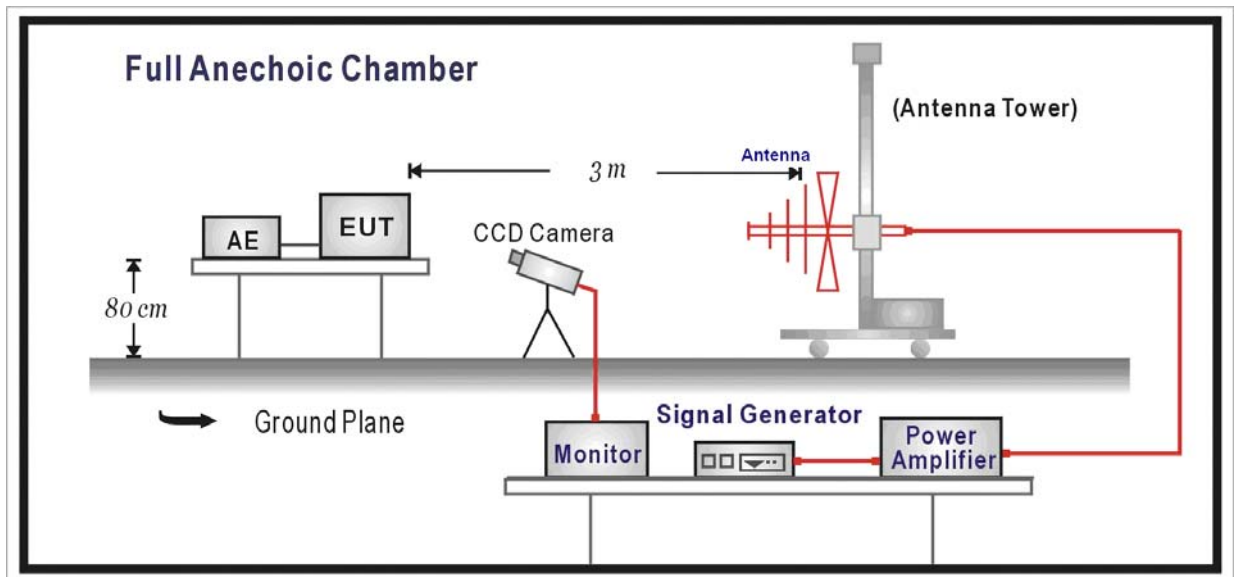

8.3. Limit

Item	Environmental Phenomena	Units	Test Specification	Performance Criteria
Enclosure Port				
	Radio-Frequency Electromagnetic Field	MHz	80-1000	A
	Amplitude Modulated	V/m(Un-modulated, rms)	3	
		% AM (1kHz)	80	

8.4. Test Procedure

The EUT and load, which are placed on a table that is 0.8 meter above ground, are placed with one coincident with the calibration plane such that the distance from antenna to the EUT was 3 meters.

Both horizontal and vertical polarization of the antenna and four sides of the EUT are set on measurement.

In order to judge the EUT performance, a CCD camera is used to monitor EUT screen.

All the scanning conditions are as follows:

Condition of Test	Remarks
1. Field Strength	3 V/m Level 2
2. Radiated Signal	AM 80% Modulated with 1kHz
3. Scanning Frequency	80MHz - 1000MHz
4. Dwell Time	3 Seconds
5. Frequency step size Δf :	1%
6. The rate of Swept of Frequency	1.5×10^{-3} decades/s

8.5. Deviation from Test Standard

No deviation.

8.6. Test Result

Product	SATA Flash Drive		
Test Item	Radiated susceptibility		
Test Mode	Mode 1: Normal Operation		
Date of Test	2013/11/26	Test Site	Chamber5

Frequency (MHz)	Position (Angle)	Polarity (H or V)	Field Strength (V/m)	Required Criteria	Complied To Criteria (A,B,C)	Results
80-1000	0°	H	3	A	A	PASS
80-1000	0°	V	3	A	A	PASS
80-1000	90°	H	3	A	A	PASS
80-1000	90°	V	3	A	A	PASS
80-1000	180°	H	3	A	A	PASS
80-1000	180°	V	3	A	A	PASS
80-1000	270°	H	3	A	A	PASS
80-1000	270°	V	3	A	A	PASS

Note:

The testing performed is from lowest level up to the highest level as required by standard, but only highest level is shown on the report.

- Meet criteria A: Operate as intended during and after the test
- Meet criteria B: Operate as intended after the test
- Meet criteria C: Loss/Error of function
- Additional Information
 - There was no observable degradation in performance.
 - EUT stopped operation and could / could not be reset by operator at _____ V/m at frequency _____MHz.
- No false alarms or other malfunctions were observed during or after the test.

8.7. Test Photograph

Test Mode : Mode 1: Normal Operation

Description : Radiated Susceptibility Test Setup



9. Electrical Fast Transient/Burst

9.1. Test Specification

According to Standard : IEC 61000-4-4

9.2. Test Setup

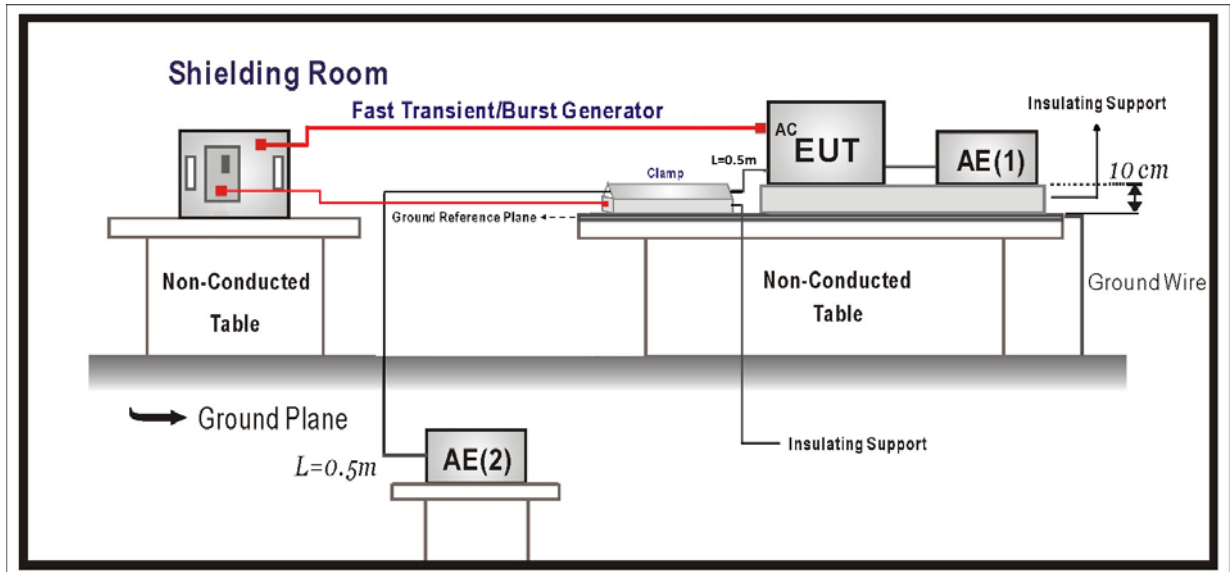

9.3. Limit

Item	Environmental Phenomena	Units	Test Specification	Performance Criteria
I/O and communication ports				
	Fast Transients Common Mode	kV (Peak) Tr/Th ns Rep. Frequency kHz	+0.5 5/50 5	B
Input DC Power Ports				
	Fast Transients Common Mode	kV (Peak) Tr/Th ns Rep. Frequency kHz	+0.5 5/50 5	B
Input AC Power Ports				
	Fast Transients Common Mode	kV (Peak) Tr/Th ns Rep. Frequency kHz	+1 5/50 5	B

9.4. Test Procedure

The EUT is placed on a table that is 0.8 meter height. A ground reference plane is placed on the table, and uses a 0.1m insulation between the EUT and ground reference plane.

The minimum area of the ground reference plane is 1m*1m, and 0.65mm thick min, and projected beyond the EUT by at least 0.1m on all sides.

Test on I/O and communication ports:

The EFT interference signal is through a coupling clamp device couples to the signal and control lines of the EUT with burst noise for 1 minute.

Test on power supply ports:

The EUT is connected to the power mains through a coupling device that directly couples the EFT/B interference signal.

Each of the Line and Neutral conductors is impressed with burst noise for 1 minute.

The length of the signal and power lines between the coupling device and the EUT is 0.5m.

9.5. Deviation from Test Standard

No deviation.

9.6. Test Result

Product	SATA Flash Drive		
Test Item	Electrical fast transient/burst		
Test Mode	Mode 1: Normal Operation		
Date of Test	2013/11/26	Test Site	No.3 Shielded Room

Inject Line	Polarity	Voltage kV	Inject Time (Second)	Inject Method	Required Criteria	Complied to Criteria	Result
L	±	1kV	60	Direct	B	A	PASS
N	±	1kV	60	Direct	B	A	PASS
PE	±	1kV	60	Direct	B	A	PASS
L-N-PE	±	1kV	60	Direct	B	A	PASS

Note:

The testing performed is from lowest level up to the highest level as required by standard, but only highest level is shown on the report.

- Meet criteria A : Operate as intended during and after the test
- Meet criteria B : Operate as intended after the test
- Meet criteria C : Loss/Error of function
- Additional Information
 - EUT stopped operation and could / could not be reset by operator at _____ kV of Line _____.
- No false alarms or other malfunctions were observed during or after the test.

9.7. Test Photograph

Test Mode : Mode 1: Normal Operation

Description : EFT/B Test Setup



10. Surge

10.1. Test Specification

According to Standard : IEC 61000-4-5

10.2. Test Setup

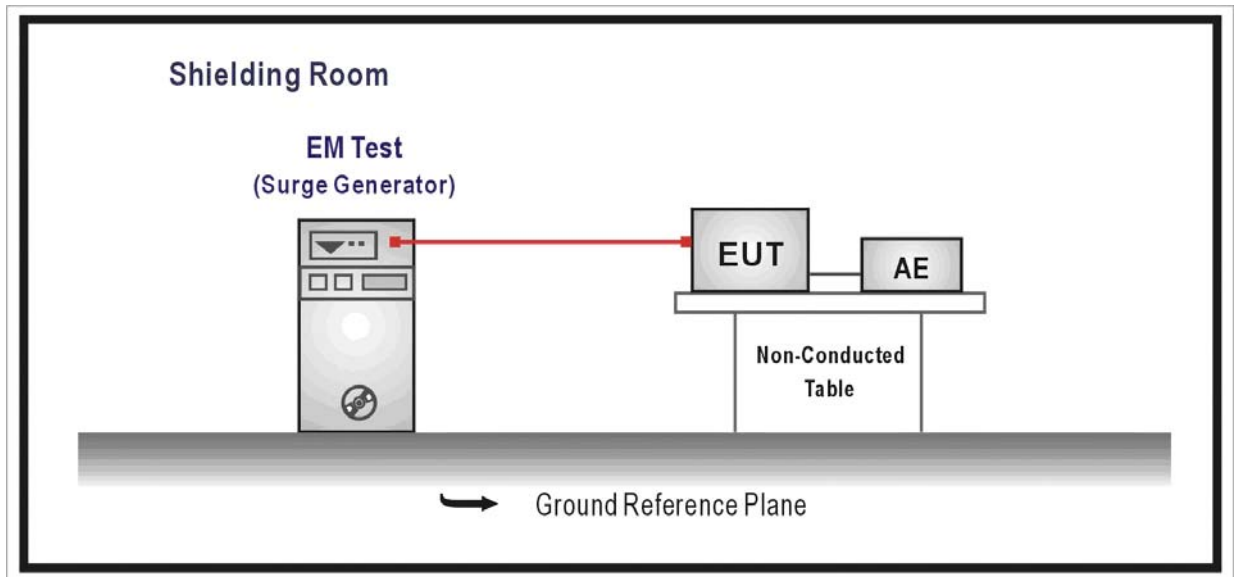

10.3. Limit

Item	Environmental Phenomena	Units	Test Specification	Performance Criteria
Signal Ports and Telecommunication Ports(See 1) and 2))				
	Surges Line to Ground	Tr/Th us kV	10/700 ± 1	C
Input DC Power Ports				
	Surges Line to Ground	Tr/Th us kV	1.2/50 (8/20) ± 0.5	B
AC Input and AC Output Power Ports				
	Surges Line to Line Line to Ground	Tr/Th us kV kV	1.2/50 (8/20) ± 1 ± 2	B

Notes:

- 1) Applicable only to ports which according to the manufacturer’s specification may connect directly to outdoor cables.
- 2) Where the coupling network for the 10/700 μs waveform affects the functioning of high speed data ports, the test shall be carried out using a 1,2/50 (8/20) μs waveform and appropriate coupling network.

10.4. Test Procedure

The EUT and its load are placed on a table that is 0.8 meter above a metal ground plane measured 1m*1m min. and 0.65mm thick min. And projected beyond the EUT by at least 0.1m on all sides. The length of power cord between the coupling device and the EUT shall be 2m or less.

For Input and Output AC Power or DC Input and DC Output Power Ports:

The EUT is connected to the power mains through a coupling device that directly couples the Surge interference signal.

The surge noise shall be applied synchronized to the voltage phase at 0° , 90° , 180° , 270° and the peak value of the a.c. voltage wave. (Positive and negative)

Each of Line-Earth and Line-Line is impressed with a sequence of five surge voltages with interval of 1 min.

10.5. Deviation from Test Standard

No deviation.

10.6. Test Result

Product	SATA Flash Drive		
Test Item	Surge		
Test Mode	Mode 1: Normal Operation		
Date of Test	2013/11/26	Test Site	No.3 Shielded Room

Inject Line	Polarity	Voltage kV	Angle	Time Interval (Second)	Inject Method	Required Criteria	Complied to Criteria	Result
L-N	±	1kV	0	60	Direct	B	A	PASS
L-N	±	1kV	90	60	Direct	B	A	PASS
L-N	±	1kV	180	60	Direct	B	A	PASS
L-N	±	1kV	270	60	Direct	B	A	PASS
L-PE	±	2kV	0	60	Direct	B	A	PASS
L-PE	±	2kV	90	60	Direct	B	A	PASS
L-PE	±	2kV	180	60	Direct	B	A	PASS
L-PE	±	2kV	270	60	Direct	B	A	PASS
N-PE	±	2kV	0	60	Direct	B	A	PASS
N-PE	±	2kV	90	60	Direct	B	A	PASS
N-PE	±	2kV	180	60	Direct	B	A	PASS
N-PE	±	2kV	270	60	Direct	B	A	PASS

Note:

The testing performed is from lowest level up to the highest level as required by standard, but only highest level is shown on the report.

- Meet criteria A : Operate as intended during and after the test
- Meet criteria B : Operate as intended after the test
- Meet criteria C : Loss/Error of function
- Additional Information
 - EUT stopped operation and could / could not be reset by operator at _____ kV of Line _____.
- No false alarms or other malfunctions were observed during or after the test.

10.7. Test Photograph

Test Mode : Mode 1: Normal Operation

Description : SURGE Test Setup



11. Conducted Susceptibility

11.1. Test Specification

According to Standard : IEC 61000-4-6

11.2. Test Setup

CDN Inject Method

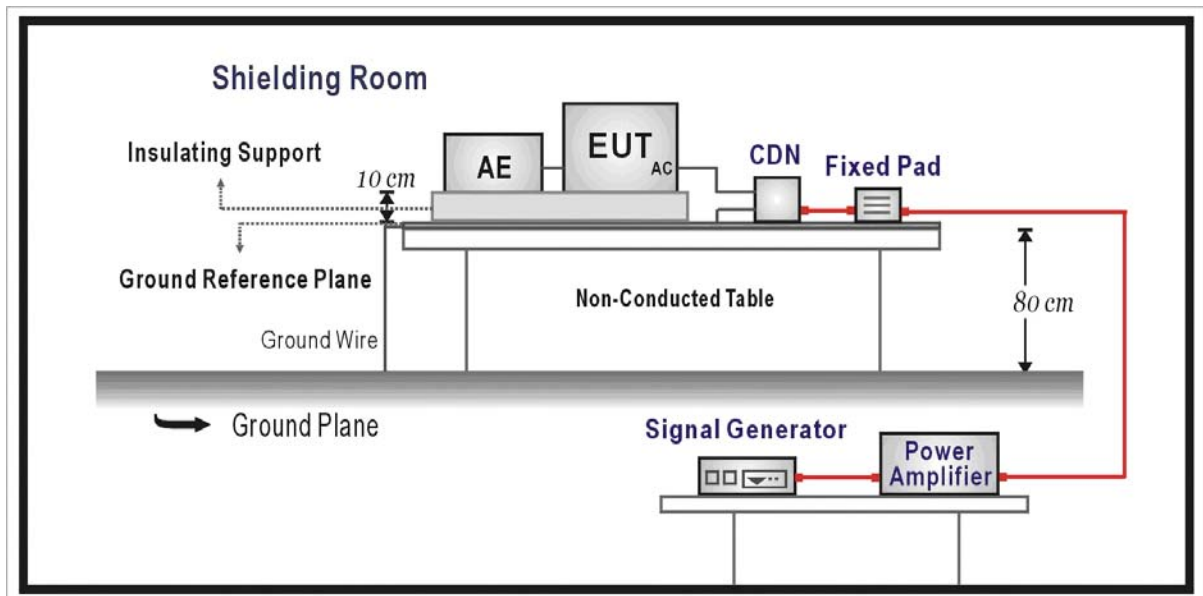

EM Clamp Inject Method

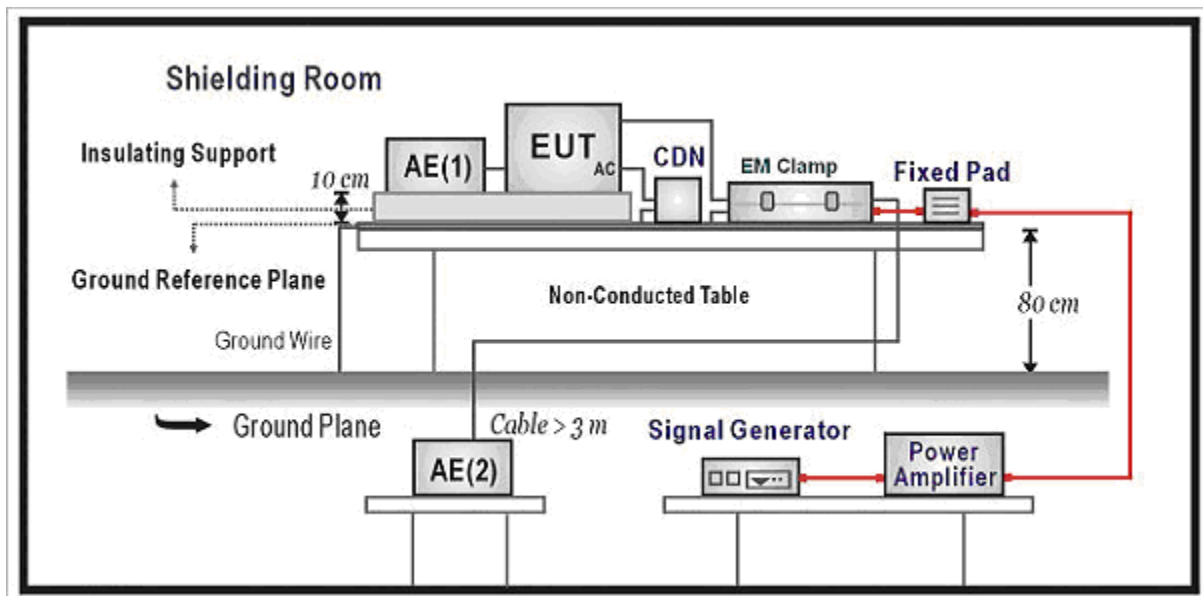

11.3. Limit

Item	Environmental Phenomena	Units	Test Specification	Performance Criteria
Signal Ports and Telecommunication Ports				
	Radio-Frequency Continuous Conducted	MHz V (rms, Un-modulated) % AM (1kHz)	0.15-80 3 80	A
Input DC Power Ports				
	Radio-Frequency Continuous Conducted	MHz V (rms, Un-modulated) % AM (1kHz)	0.15-80 3 80	A
Input AC Power Ports				
	Radio-Frequency Continuous Conducted	MHz V (rms, Un-modulated) % AM (1kHz)	0.15-80 3 80	A

11.4. Test Procedure

The EUT are placed on a table that is 0.8 meter height, and a Ground reference plane on the table, EUT are placed upon table and use a 10cm insulation between the EUT and Ground reference plane.

For Signal Ports and Telecommunication Ports

The disturbance signal is through a coupling and decoupling networks (CDN) or EM-clamp device couples to the signal and Telecommunication lines of the EUT.

For Input DC and AC Power Ports

The EUT is connected to the power mains through a coupling and decoupling networks for power supply lines. And directly couples the disturbances signal into EUT.

Used CDN-M2 for two wires or CDN-M3 for three wires.

All the scanning conditions are as follows:

Condition of Test	Remarks
1. Field Strength	130dBuV(3V) Level 2
2. Radiated Signal	AM 80% Modulated with 1kHz
3. Scanning Frequency	0.15MHz – 80MHz
4. Dwell Time	3 Seconds
5. Frequency step size Δf :	1%
6. The rate of Swept of Frequency	1.5×10^{-3} decades/s

11.5. Deviation from Test Standard

No deviation.

11.6. Test Result

Product	SATA Flash Drive		
Test Item	Conducted susceptibility		
Test Mode	Mode 1: Normal Operation		
Date of Test	2013/11/26	Test Site	No.6 Shielded Room

Frequency Range (MHz)	Voltage Applied dBuV(V)	Inject Method	Tested Port of EUT	Required Criteria	Performance Criteria Complied To	Result
0.15~80	130 (3V)	CDN	AC IN	A	A	PASS

Note:

The testing performed is from lowest level up to the highest level as required by standard, but only highest level is shown on the report.

- Meet criteria A : Operate as intended during and after the test
- Meet criteria B : Operate as intended after the test
- Meet criteria C : Loss/Error of function
- Additional Information
 - EUT stopped operation and could / could not be reset by operator at _____ dBuV(V) at frequency _____MHz.
 - No false alarms or other malfunctions were observed during or after the test. The acceptance criteria were met, and the EUT passed the test.

11.7. Test Photograph

Test Mode : Mode 1: Normal Operation

Description : Conducted Susceptibility Test Setup



12. Power Frequency Magnetic Field

12.1. Test Specification

According to Standard: IEC 61000-4-8

12.2. Test Setup

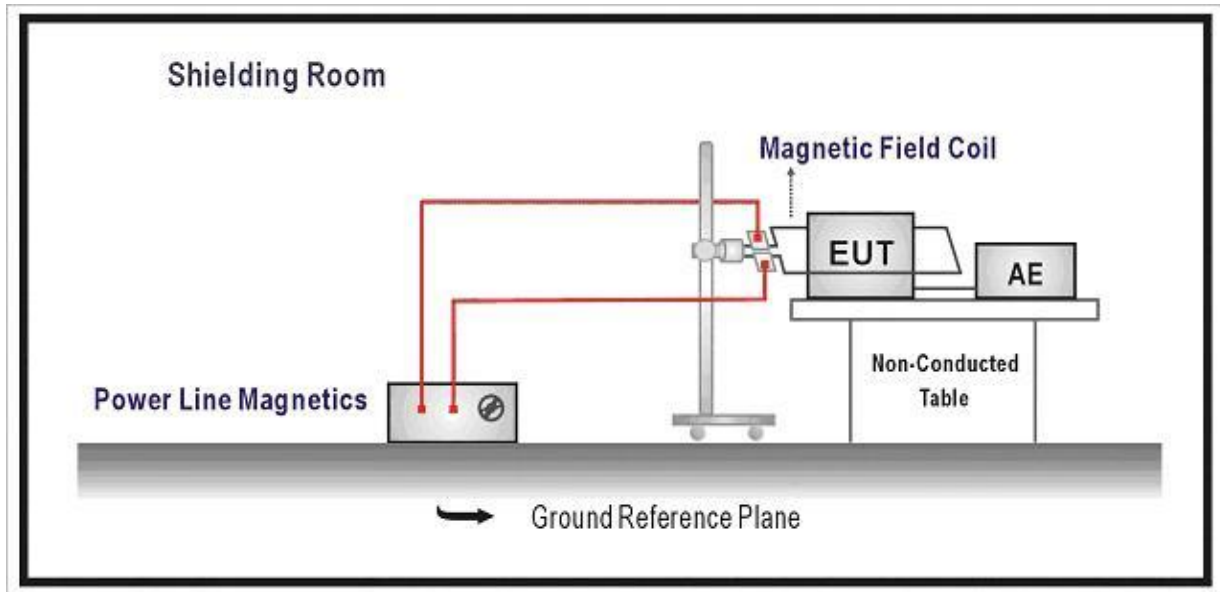

12.3. Limit

Item	Environmental Phenomena	Units	Test Specification	Performance Criteria
Enclosure Port				
	Power-Frequency Magnetic Field	Hz A/m (r.m.s.)	50 1	A

12.4. Test Procedure

The EUT and its load are placed on a table which is 0.8 meter above a metal ground plane measured at least 1m*1m min. The test magnetic field shall be placed at central of the induction coil.

The test magnetic Field shall be applied 10 minutes by the immersion method to the EUT. And the induction coil shall be rotated by 90° in order to expose the EUT to the test field with different orientation (X, Y, Z Orientations).

12.5. Deviation from Test Standard

No deviation.

12.6. Test Result

Product	SATA Flash Drive		
Test Item	Power frequency magnetic field		
Test Mode	Mode 1: Normal Operation		
Date of Test	2013/11/26	Test Site	No.3 Shielded Room

Polarization	Frequency (Hz)	Inject Time (s)	Magnetic Strength (A/m)	Required Performance Criteria	Performance Criteria Complied To	Test Result
X Orientation	50	60	1	A	A	PASS
Y Orientation	50	60	1	A	A	PASS
Z Orientation	50	60	1	A	A	PASS

- Meet criteria A: Operate as intended during and after the test
- Meet criteria B: Operate as intended after the test
- Meet criteria C: Loss/Error of function
- Additional Information
 - EUT stopped operation and could / could not be reset by operator at _____ kV of Line _____.
- No false alarms or other malfunctions were observed during or after the test. The acceptance criteria were met, and the EUT passed the test.

12.7. Test Photograph

Test Mode : Mode 1: Normal Operation

Description : Power Frequency Magnetic Field Test Setup



13. Voltage Dips and Interruption

13.1. Test Specification

According to Standard : IEC 61000-4-11

13.2. Test Setup

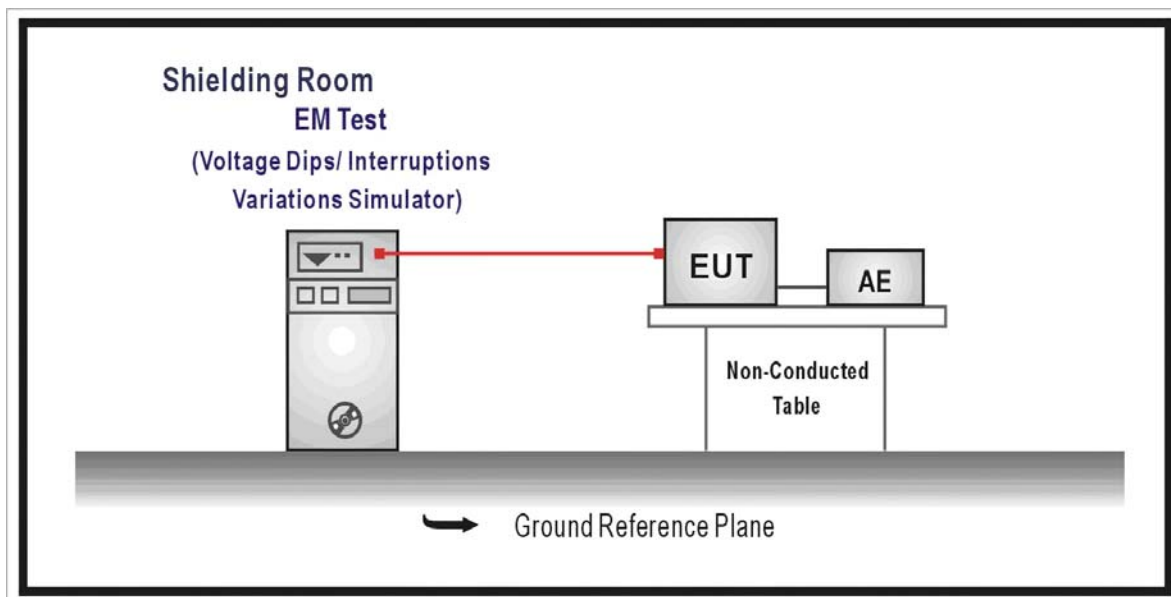

13.3. Limit

Item	Environmental Phenomena	Units	Test Specification	Performance Criteria
Input AC Power Ports				
Voltage Dips		% Reduction	30	C
		Period	25	
Voltage Interruptions		% Reduction	>95	B
		Period	0.5	
Voltage Interruptions		% Reduction	> 95	C
		Period	250	

13.4. Test Procedure

The EUT and its load are placed on a table which is 0.8 meter above a metal ground plane measured 1m*1m min. And 0.65mm thick min. And projected beyond the EUT by at least 0.1m on all sides. The power cord shall be used the shortest power cord as specified by the manufacturer.

For Voltage Dips/ Interruptions test:

The selection of test voltage is based on the rated power range. If the operation range is large than 20% of lower power range, both end of specified voltage shall be tested.

Otherwise, the typical voltage specification is selected as test voltage.

The EUT is connected to the power mains through a coupling device that directly couples to the Voltage Dips and Interruption Generator.

The EUT shall be tested for 30% voltage dip of supplied voltage and duration 25 Periods, for 95% voltage dip of supplied voltage and duration 0.5 Periods with a sequence of three voltage dips with intervals of 10 seconds, and for 95% voltage interruption of supplied voltage and duration 250 Periods with a sequence of three voltage interruptions with intervals of 10 seconds.

Voltage phase shifting are shall occur at 0° , 45° , 90° , 135° , 180° , 225° , 270° , 315° of the voltage.

13.5. Deviation from Test Standard

No deviation.

13.6. Test Result

Product	SATA Flash Drive		
Test Item	Voltage dips and interruption		
Test Mode	Mode 1: Normal Operation		
Date of Test	2013/11/26	Test Site	No.3 Shielded Room

Voltage Dips and Interruption Reduction(%)	Angle	Test Duration (Periods)	Required Performance Criteria	Performance Criteria Complied To	Test Result
30	0	25	C	A	PASS
30	45	25	C	A	PASS
30	90	25	C	A	PASS
30	135	25	C	A	PASS
30	180	25	C	A	PASS
30	225	25	C	A	PASS
30	270	25	C	A	PASS
30	315	25	C	A	PASS
>95	0	0.5	B	A	PASS
>95	45	0.5	B	A	PASS
>95	90	0.5	B	A	PASS
>95	135	0.5	B	A	PASS
>95	180	0.5	B	A	PASS
>95	225	0.5	B	A	PASS
>95	270	0.5	B	A	PASS
>95	315	0.5	B	A	PASS
>95	0	250	C	C	PASS
>95	45	250	C	C	PASS
>95	90	250	C	C	PASS
>95	135	250	C	C	PASS
>95	180	250	C	C	PASS
>95	225	250	C	C	PASS
>95	270	250	C	C	PASS
>95	315	250	C	C	PASS

- Meet criteria A: Operate as intended during and after the test
- Meet criteria B: Operate as intended after the test
- Meet criteria C: Loss/Error of function
- Additional Information
 - The nominal voltage of EUT is 230V.
 - EUT stopped operation and could / could not be reset by operator at _____ kV of Line _____.
- No false alarms or other malfunctions were observed during or after the test. The acceptance criteria were met, and the EUT passed the test.

13.7. Test Photograph

Test Mode : Mode 1: Normal Operation

Description : Voltage Dips Test Setup



14. Attachment

➤ EUT Photograph

(1) EUT Photo



(2) EUT Photo

